

rengarenk  
kids & young furniture

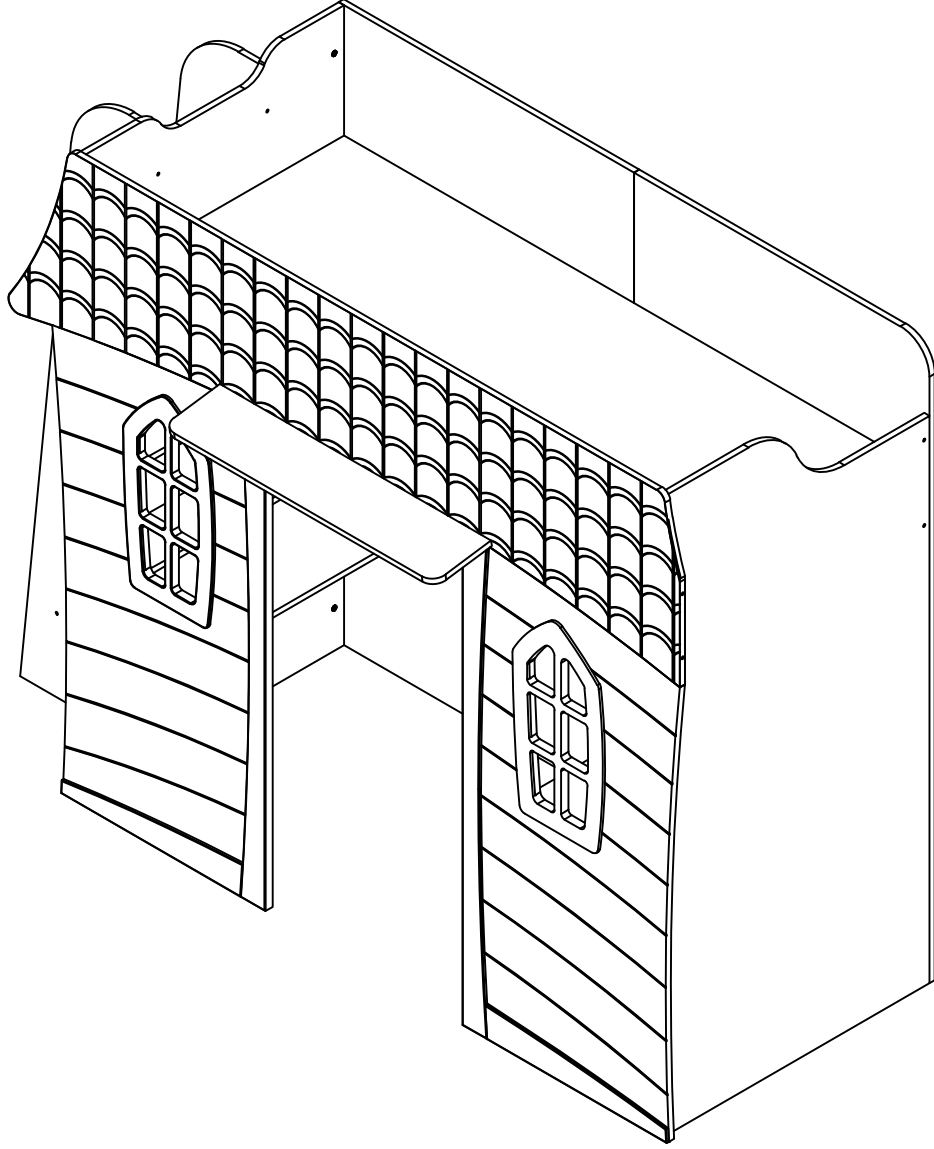

# My World Combo 90x200

product code = 548-11-01

# My World Karyola 90x200

Ürün Kodu = 548-11-01

## WARNING & GENERAL CLEANING RECOMMENDATIONS



- Clean your furniture with a damp soft cloth and dry it.
- Never use any chemical cleaning agent, hard materials, materials consisting of acid, base (such as detergent, bleach) for cleaning.
- Wipe stains on surfaces such as glass and mirror with a dry soft cloth. Stubborn stains should be cleaned with a well squeezed cloth soaked in warm water. Be careful not to leave any water drops on the bottom surface.
- Wipe and dry any hot or cold liquid that spills on the surface of your furniture immediately. Furniture shouldn't be contacted with chemical solvents such as alcohol, acetone, thinner, etc.
- Materials cutting, scratching, etc. (such as key) shouldn't be thrown on painted surface of our furniture.
- Furniture shouldn't be kept in areas where they are exposed to direct sunlight. Materials at high temperatures shouldn't be put directly on the surface of our furniture (cup, etc.)
- Do not expose products to heaters such as electric heaters or stoves. For products with different production dates, the color tone may be different. The reason for the difference in tone that can be seen in different parts of the same product is that it is covered with a different pattern of natural coating material. In addition, this condition which depends on factors such as the age of the tree, grain structure, exposure and climate, shouldn't be perceived as a mistake.
- Stickers and/or posters shouldn't be attached to the product surface.
- Glasses of units with glass door and mirror shouldn't be closed swiftly and harshly.
- Doors and drawers shouldn't be open while products are being transported.
- Carriage of drawer units such as dresser, nightstand, etc. shouldn't be performed horizontally on the drawer side.
- Products should be kept at least 60 in away from the heaters such as radiator, etc.
- Electrical accessories shouldn't be left on for a long time.
- Cleaning of the stickers included in the product design should be done without removing it (without disconnecting) from such area.
- Units shouldn't be used for purposes other than their intended use. For example, it shouldn't be stepped on desk, nightstand, dresser, bookcase, wardrobe.
- Place heaviest items in the lower drawers.
- Unless specifically designed to accommodate, do not set TVs or other heavy objects on top of this product.



- Never allow children to climb or hang on drawers , doors or shelves.
- Do not simultaneously open drawers and doors of products with multiple drawers (such as dresser, nightstand, etc.). This causes change in position of the center of gravity and it may fall over.
- Check periodically whether hinges used on doors of your furniture are intact. So, you can prevent doors from falling.
- Do not carry your furniture by pushing or dragging. Carry moving parts and disassembled products by dismantling. (such as shelf, door)
- While carrying mounted products or changing their places, carry them by tilting towards opposite side of drawers' opening direction. (drawers may open and fall.)
- There are stairs on bunk beds to climb upper bed section. While climbing upper bed section, use stair steps.
- Place heavy objects on lower shelves of bookcases, light objects on upper shelves.
- If desk wheels are movable, make sure that the wheels are not in the locked position except for carrying to other places.
- In case of changing place, if products are mounted, please receive help from authorized service about transportation by disassembling and installation in substitution place.
- Installation of the products is seller's liability. Installation guide is included in the package of each product and unit.
- Show all necessary care and attention to minimize the risks that may arise in natural disasters such as earthquake, flood, fire etc. Especially in the event of earthquake, fix products that may create risk by falling over, falling or sliding to the wall. Determination of the location of the electric and plumbing pipes while fixing the product, selection of fittings suitable for the type and weight of the product, selection of fixing elements and maintaining its balance are important. In the reduction of risks, carrying heavy and high products to areas where we will be safer, placing furniture used permanently in areas away from windows and putting heavy items on lower shelves and putting lighter items on upper shelves are simple measures to be taken. If requested during assembly provided by the seller, it will be helped to reduce risks due to natural disasters, to fix hardware and accessories, to provide apparatus and to fix related items to wall with these

## UYARI & GENEL TEMİZLİK ÖNERİLERİ



- Mobilyalarınızın temizliğini nemli yumusak bir bezle yapınız ve kurulayınız.
- Temizlik için kesinlikle asit, baz içerikli maddeler (deterjan, çamasır suyu gibi ) tüm kimyasal temizlik maddeleri sert cisimler kullanmayınız.
- Cam – ayna gibi yüzeylerde oluşan lekeleri kuru yumusak bir bezle siliniz İnatçı lekeler duru sıcak suya batırılarak iyice sıkılmış bez ile temizlenmelidir. Alt yüzeyde su damlacıkları kalmamasına dikkat ediniz.
- Mobilyalarınızın yüzeyine dökülen sıcak veya soğuk her türlü sıvıyı derhal siliniz ve kurulayınız.
- Mobilyalarınızın boya kaplaması yüzeyine , kesici, çizici vs. (anahtar gibi) maddeler atılmamalıdır.
- Mobilyalarınızın, direkt güneş ışığına maruz kalacak bölümlerde bulundurulmamalıdır. Mobilyalarınızın yüzeyine direkt olarak yüksek sıcaklıktaki maddeler konulmamalıdır. (çaydanlık, tencere vs.)
- Elektrikli ısıtıcı ve soba gibi ısıtıcılara ürünleri maruz bırakmayınız. Farklı üretim tarihli ürünlerde renk tonu farkı olabilir. Aynı ürünün değişik parçalarında görülebilecek ton farkının nedeni ise doğal kaplama malzemesinin farklı desenine kaplanmış olmasıdır. Ayrıca , ağacın yası, damar yapısı, yetistigi baki, iklim gibi etmenlere bağlı olan bu durum bir hata olarak algılanmamalıdır.
- Ürün yüzeyine , çıkartma etiket ve/veya poster yapıştırılmamalıdır.
- Cam kapaklı ve aynalı ünitelerin camları sert ve hızlı bir şekilde kapatılmamalıdır.
- Ürünler taşınırken kapaklar ve çekmeceler açık olmamalıdır.
- Sifonyer, komodin gibi çekmeceli ünitelerin taşıma işlemi, çekmece tarafına yatay olarak yapılmamalıdır.
- Ürünler kalorifer vs. ısıtıcılardan en az 60 cm mesafede bulundurulmalıdır.
- Elektrikli aksesuarlar uzun süre açık konumda bırakılmamalıdır.
- Ürün dizaynında yer alan yapıştırma poster ve çıkartmaların temizliği , poster yapıştırılan bölgeden çıkarılmadan (temas kesilmeden) yapılmalıdır.
- Üniteler kullanım amaçları dışında kullanılmamalıdır.Örneğin ; çalışma masası, komodin, sifonyer, kitaplık, gardıropların üzerine basılarak çıkılmamalıdır.
- Ağır olan eşyalarınızı en alt çekmecelere yerleştiriniz.
- Tv gibi ağırlık yaratacak ve mobilyanın dengesini bozacak eşyaları mobilyaların üzerine koymayınız.



- Çocuklarınızın çekmecelere, dolap kapaklarına, ya da raflara tırmanmasına izin vermeyiniz.
- Çoklu çekmeceye sahip ürünlerde (sifonyer ,komodin gibi) çekmeceleri ve kapakları aynı anda açmayınız. Ağırlık merkezinin kaymasına neden olarak devrilebilir.
- Mobilyalarınızın kapaklarında kullanılan menteselerin sağlam olup olmadığını aralıklarla kontrol ediniz. Böylece kapakların düşmesini önleyebilirsiniz.
- Mobilyalarınızı iterek veya sürükleyerek taşımayınız. Hareketli parçaları ve demonte ürünleri mutlaka sökerek taşıyınız.(raf, kapak gibi)
- Monteli ürünleri taşıırken veya yer degistirirken mutlaka çekmece açılma yönünün tersi istikamette egerek taşıyınız. (çekmeceler açılarak düşebilir.)
- Ranza ürünlerde, üst yatak bölümüne çıkmak amacıyla merdiven bulunmaktadır. Çocukların, üst yatak bölümüne çıkarken, merdiven basamaklarını kullanınız.
- Kitaplıklarda ağır cisimleri alt raflara ,hafif cisimleri üst raflara yerlestiniz.
- Çalışma masası tekerleri hareketli ise baska yerlere taşıma islemi dışında tekerlerin kapalı konumda olmasına dikkat ediniz.
- Yer degisikligi yapılacağıında ürünler monteli ise demonte hale getirilerek taşınması ve ikame yerde kurulması hususunda yetkili servisten yardım alınız.
- Montaj, satıcı yükümlülüğündedir. Montaj kılavuzu her ürün ve ünitenin paketi içerisinde yer almaktadır.
- Deprem, sel, yangın vb. dogal afetlerde meydana gelebilecek riskleri en aza indirmek için gerekli tüm dikkat ve özeni gösteriniz. Özellikle deprem sırasında devrilerek, düşerek ya da kayarak risk olusturabilecek esyaları duvara sabitleyiniz. Eşyanın sabitlenmesinde elektrik ve tesisat borularının yerlerinin belirlenmesi, eşyanın cinsine ve ağırlığına uygun bağlantı elemanlarının seçimi, dübel vida vb. sabitleme elemanlarının seçimi ve dengesinin korunması önemlidir. Risklerin azaltılmasında; Ağır ve yüksek esyaları daha güvenli olacağıımız alanlara taşımak ,sürekli kullanılan mobilyaları pencerelerden uzak alanlara yerlestinmek ve raflı mobilyalarda Satıcı tarafından verilecek montaj hizmeti sırasında talep edilmesi halinde, dogal afetler sırasında meydana gelebilecek risklerin azaltılmasına yönelik uyumlu bazı mobilyalarda sabitleme aparatlarının temin edilmesi ve ilgili esyaların bu aparatlarla duvara sabitlenmesine yardım sağlanacaktır.

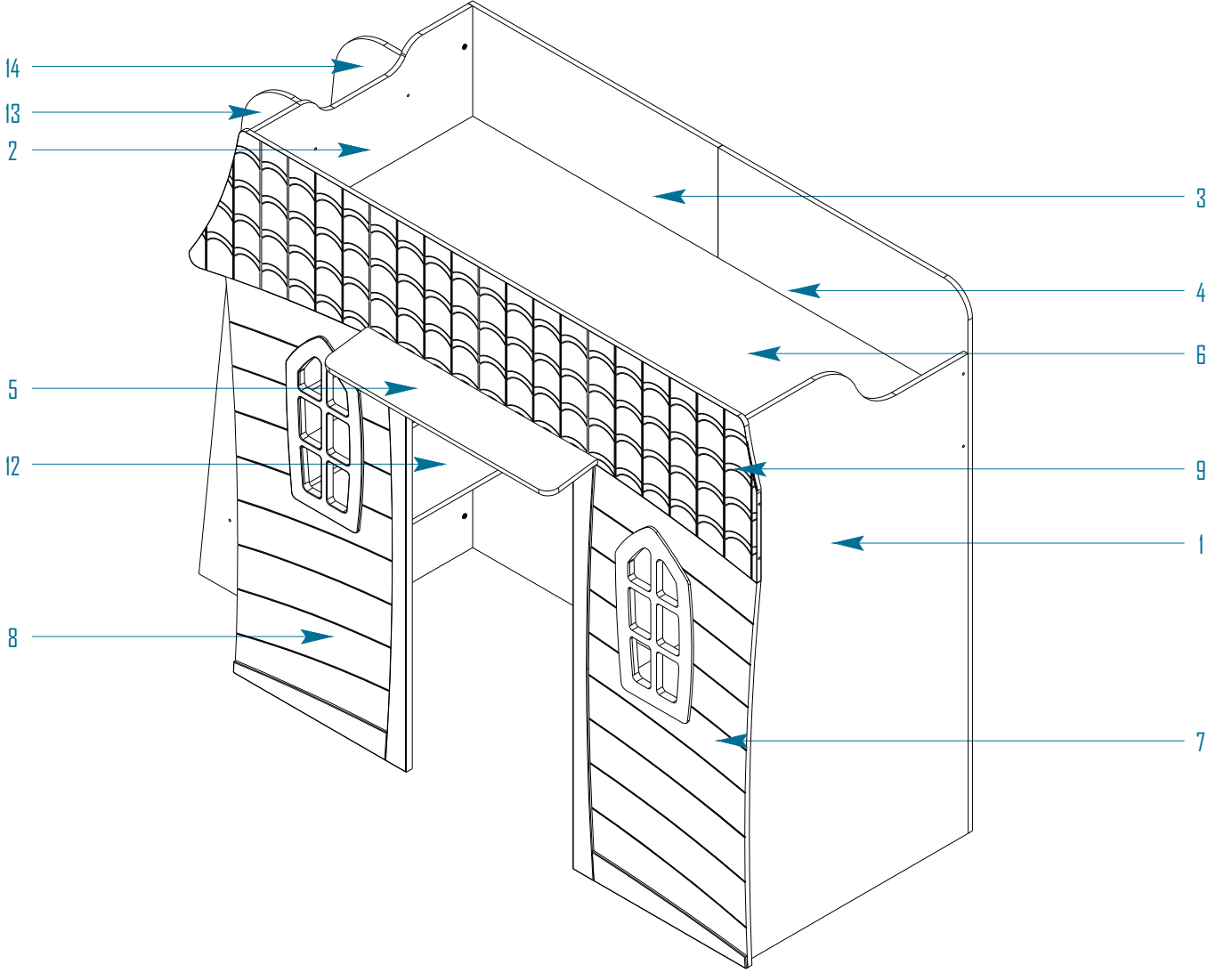

	PART NAME / PARÇA ADI	SIZE / ÖLÇÜ	PCS / ADET
1	Bed Right Board - Karyola Sag Yan	1920 x 910 - 18mm	1
2	Bed Left Board - Karyola Sol Yan	1920 x 910 - 18mm	1
3	Bed Left Back Board - Karyola Arka Pano Sol	1920 x 1023 - 18mm	1
4	Bed Right Back Board - Karyola Arka Pano Sag	1924 x 1028 - 18mm	1
5	Bed Door Top - Karyola Kapı Üstü	940 x 210 - 18mm	1
6	Bed Board Panel - Karyola Yatak Altı Suntası	2010 x 910 - 18mm	1
7	Bed Right Front Board - Karyola Sag Ön Pano	755 x 1485 - 18mm	1
8	Bed Left Front Board - Karyola Sol Ön Pano	755 x 1485 - 18mm	1
9	Bed Front Top Board - Karyola Üst Ön Pano ( Çatı )	2330 x 582 - 18mm	1
10	Study Table Panel - Çalışma Masası Tabla	910 x 500 - 18mm	1
11	Study Table Shelf I - Çalışma Masası Raf I	910 x 170 - 18mm	1
12	Bookcase Shelf - Kitaplık Raf	910 x 170 - 18mm	2
13	Ladder Right Board - Merdiven Sag Yan	910 x 170 x 18mm	4
14	Ladder Left Board - Merdiven Sol Yan	1874 x 450 x 18mm	1

## Pack and Accessory List

### Paket ve Aksesuar Listesi

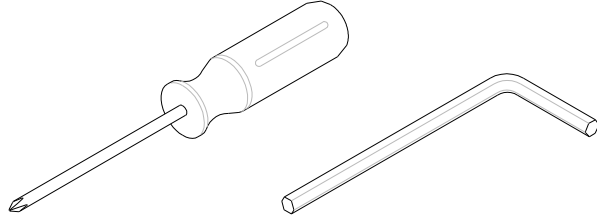
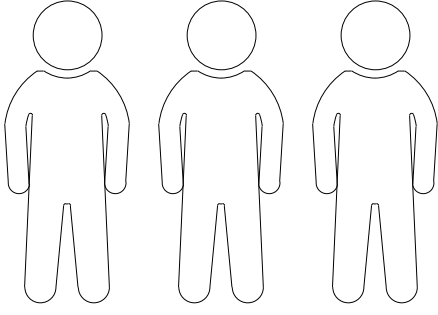

Pack / Paket 1

Pack / Paket 2

Pack / Paket 3

Pack / Paket 4

Pack / Paket 5

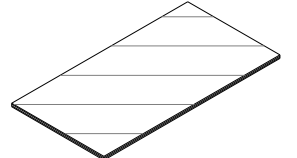
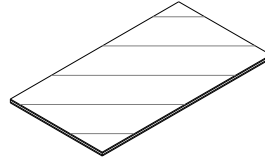
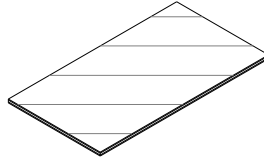
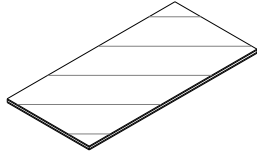
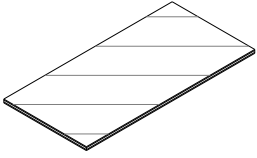

Pack / Paket 6

Pack / Paket 7

Pack / Paket 8

Pack / Paket 9

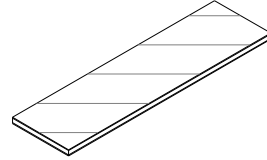
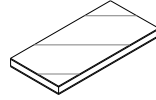
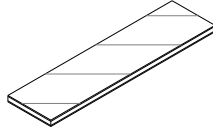
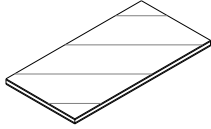

## Assembling Accessory / Montaj Aksesuarlar /

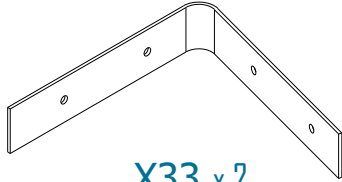

X33 x 2

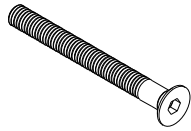

19 x 18  
(M6 x 60mm)

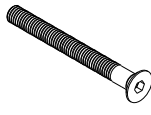

17 x 4  
(M6 x 50mm)

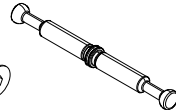

A1 x 7

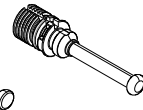

A6 x 45

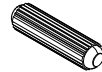

D x 42



C x 20



E x 24

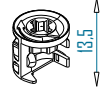

B x 59



X11 x 8

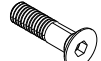

I4 x 1  
(M6 x 30mm)



I x 4  
(M6 x 15mm)



EA1 x 24

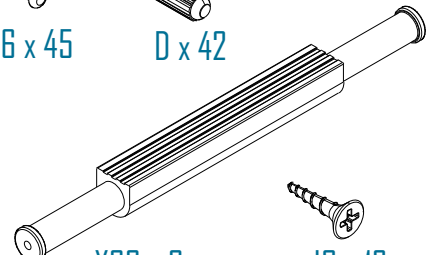

X33 x 6



J8 x 12  
(M4 x 17mm)



## Assembling Direction / Montaj Yönü :

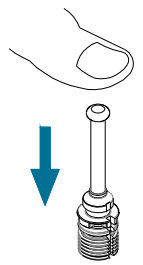
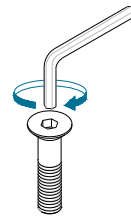
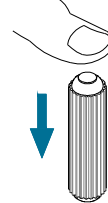
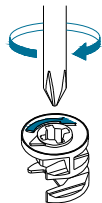
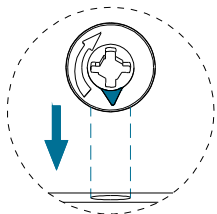

Pack / Paket 1

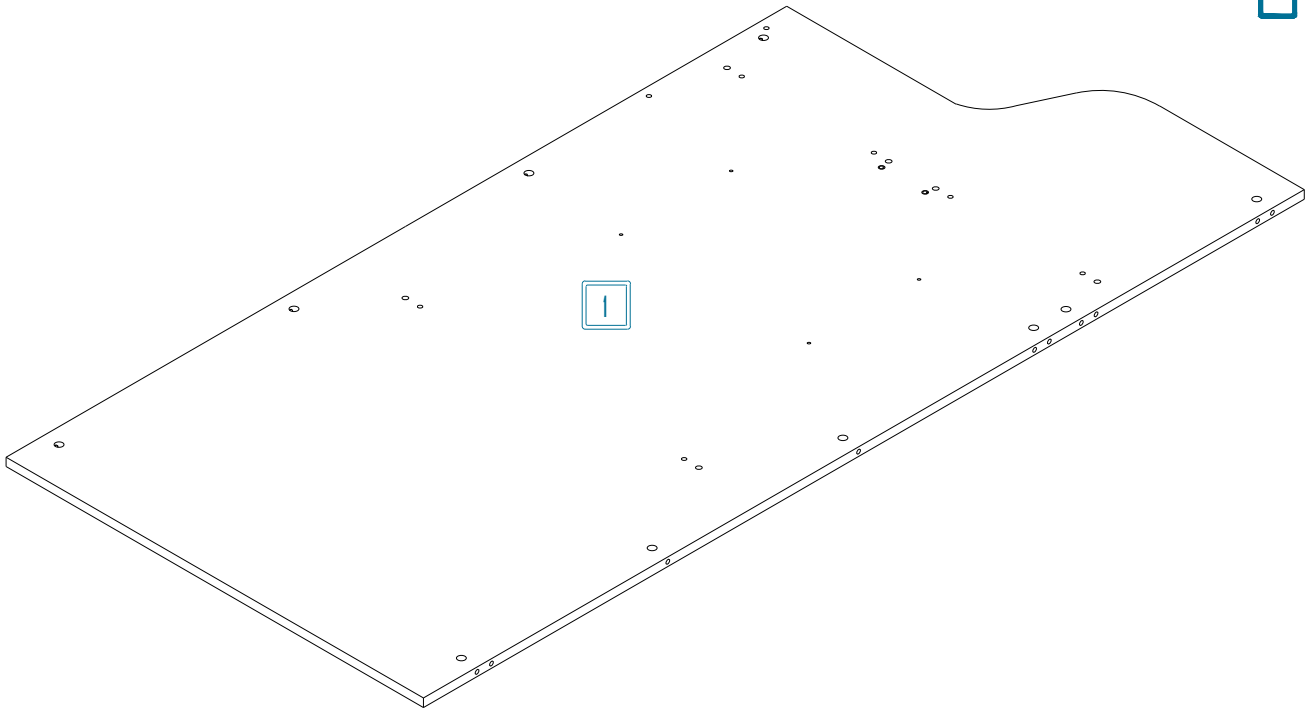

Pack / Paket 2

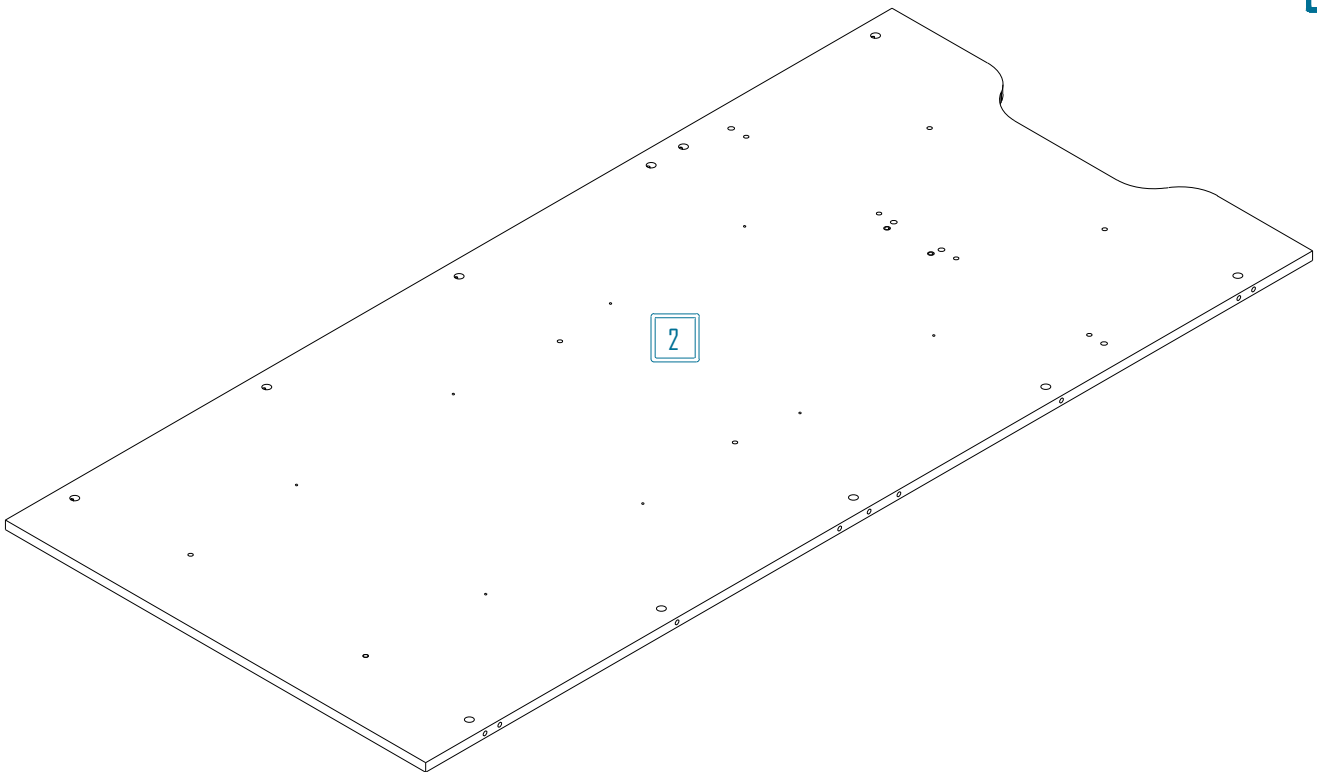



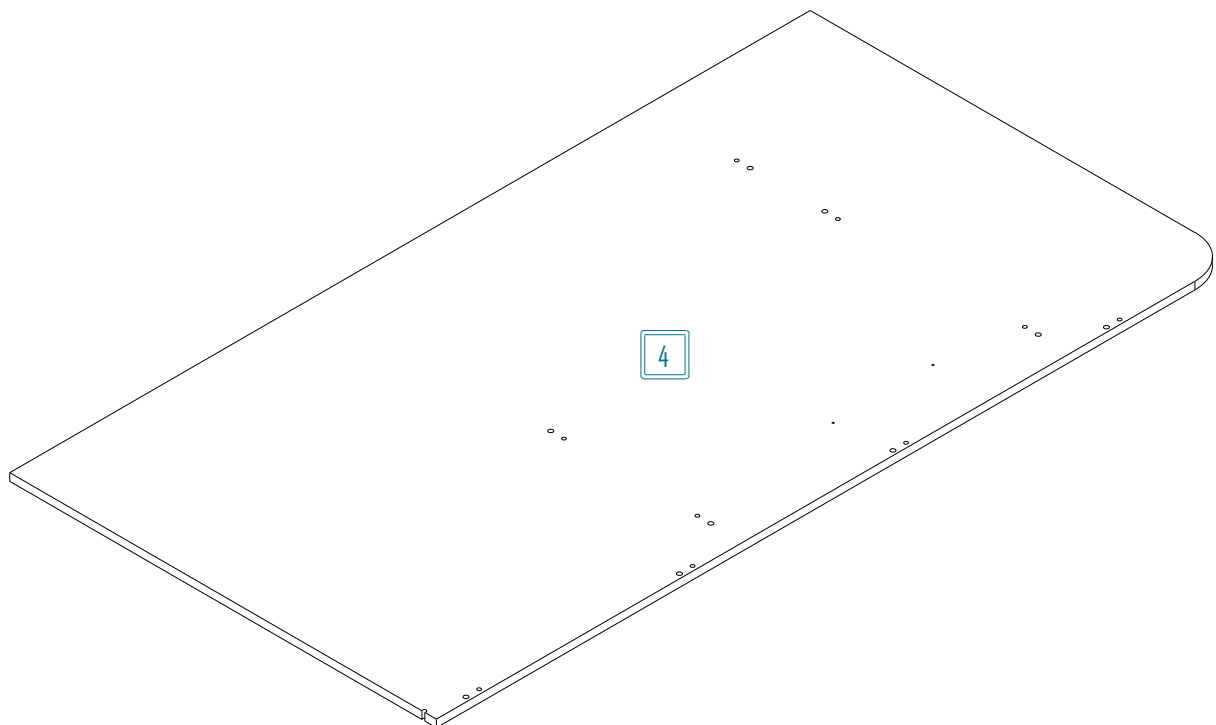
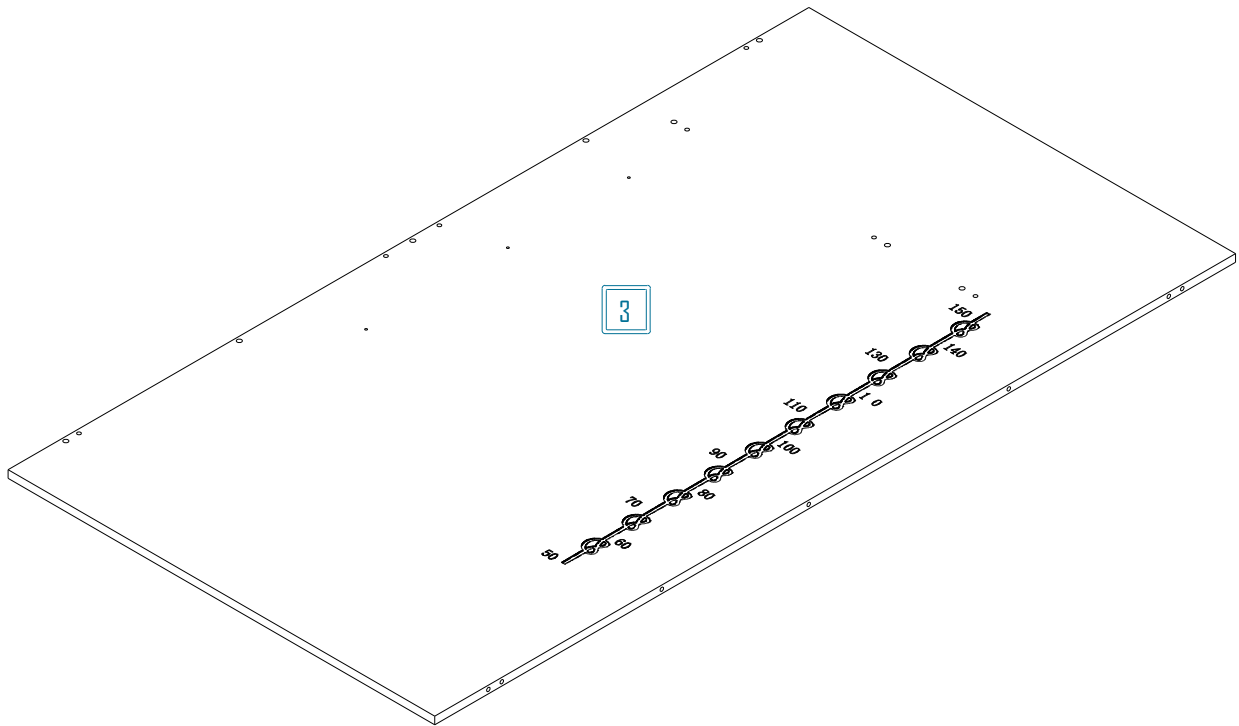

Pack / Paket 5

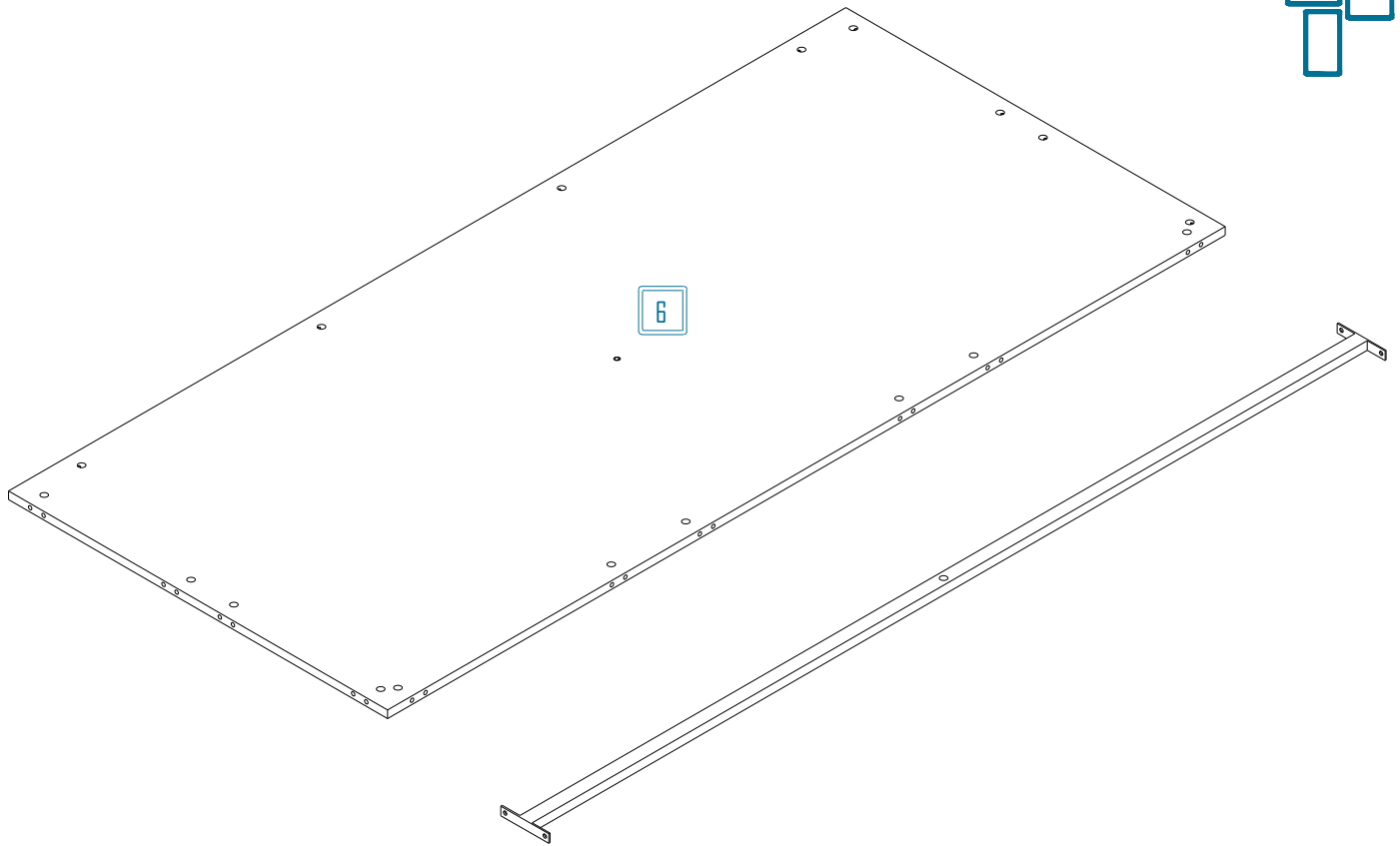

6

Pack / Paket 6

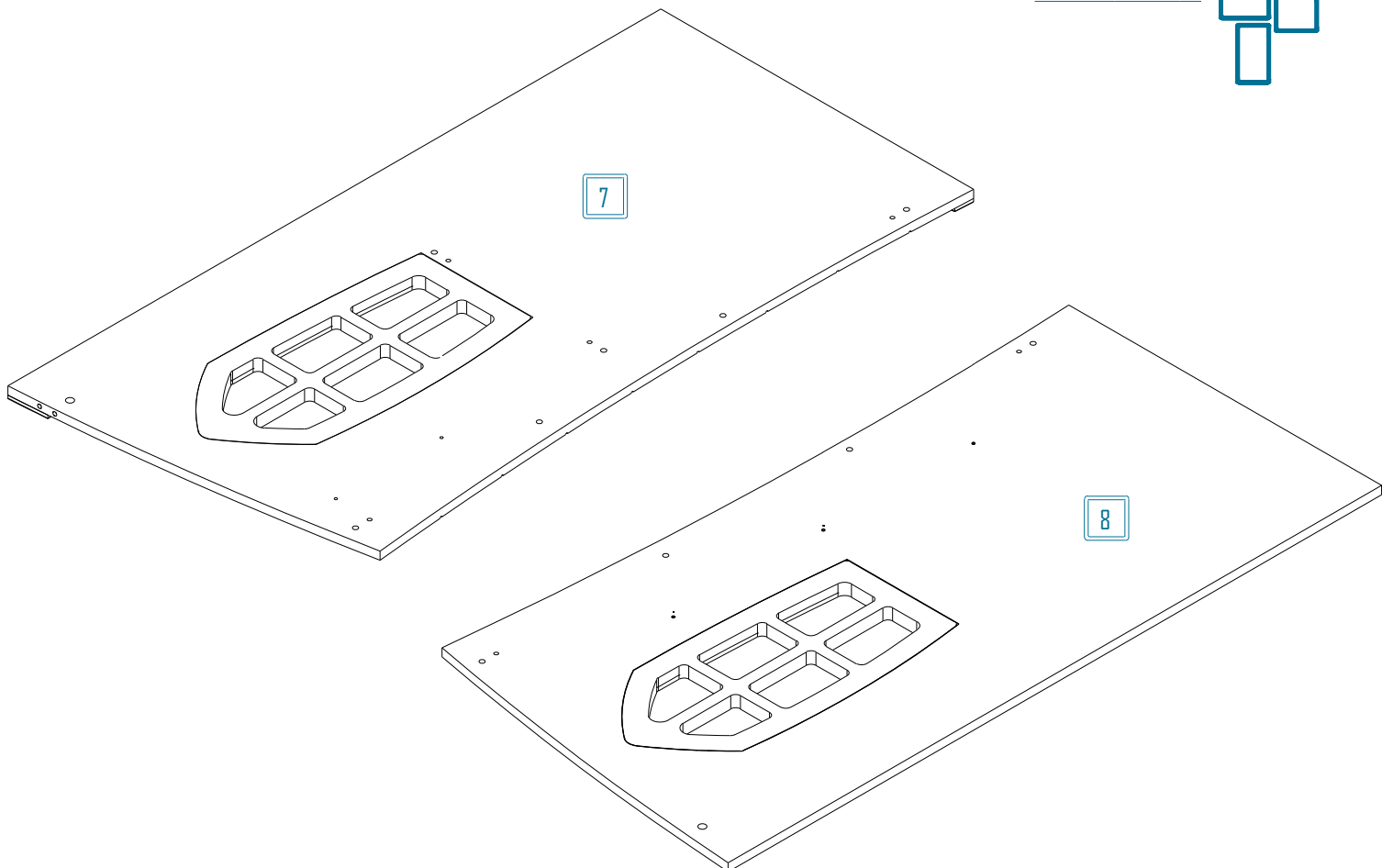

7

8

Pack / Paket 7

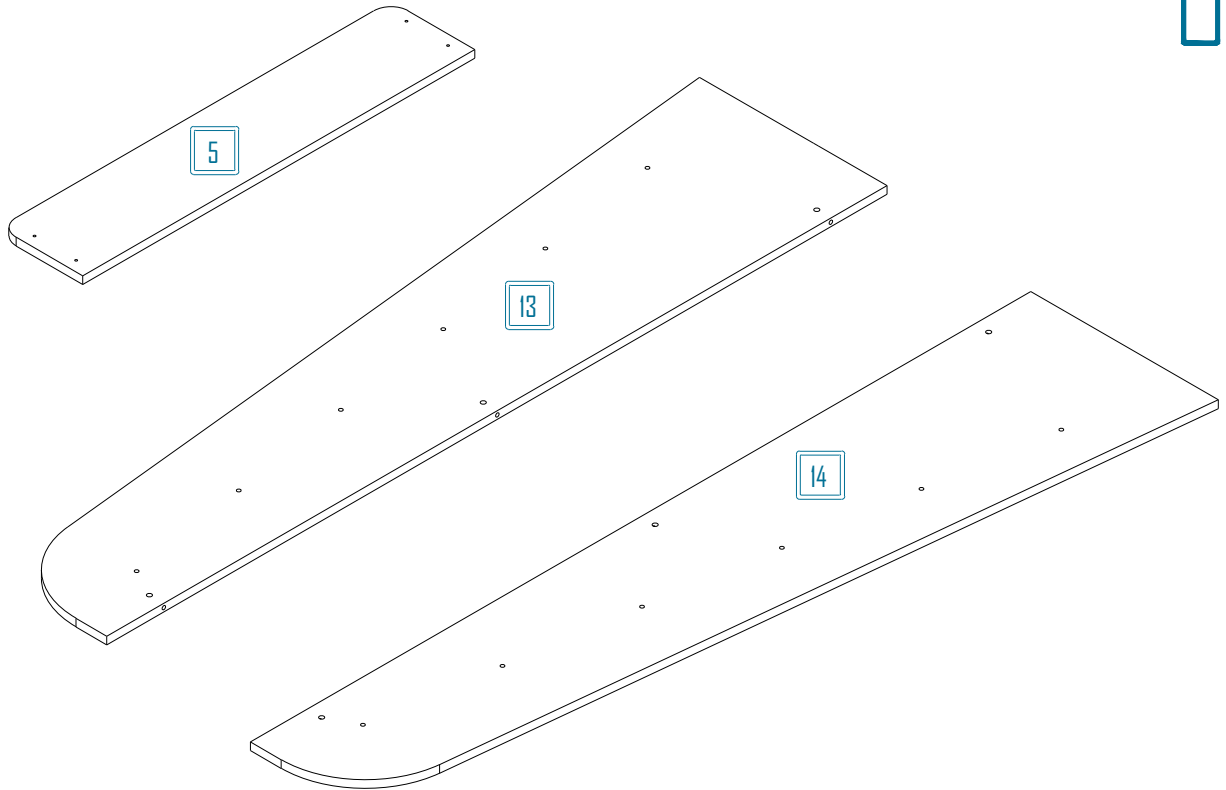

Pack / Paket 8

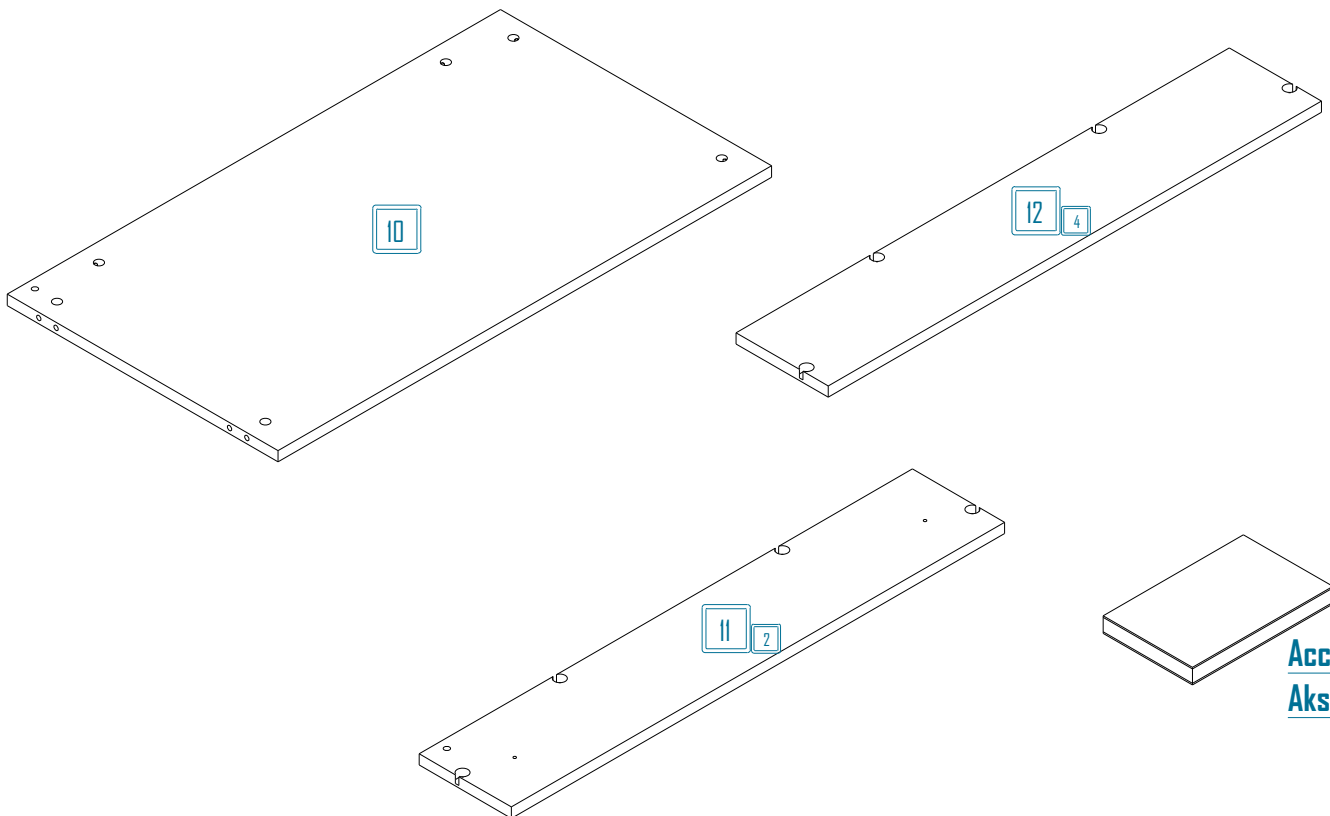

Accessory Pack  
Aksesuar Paketi

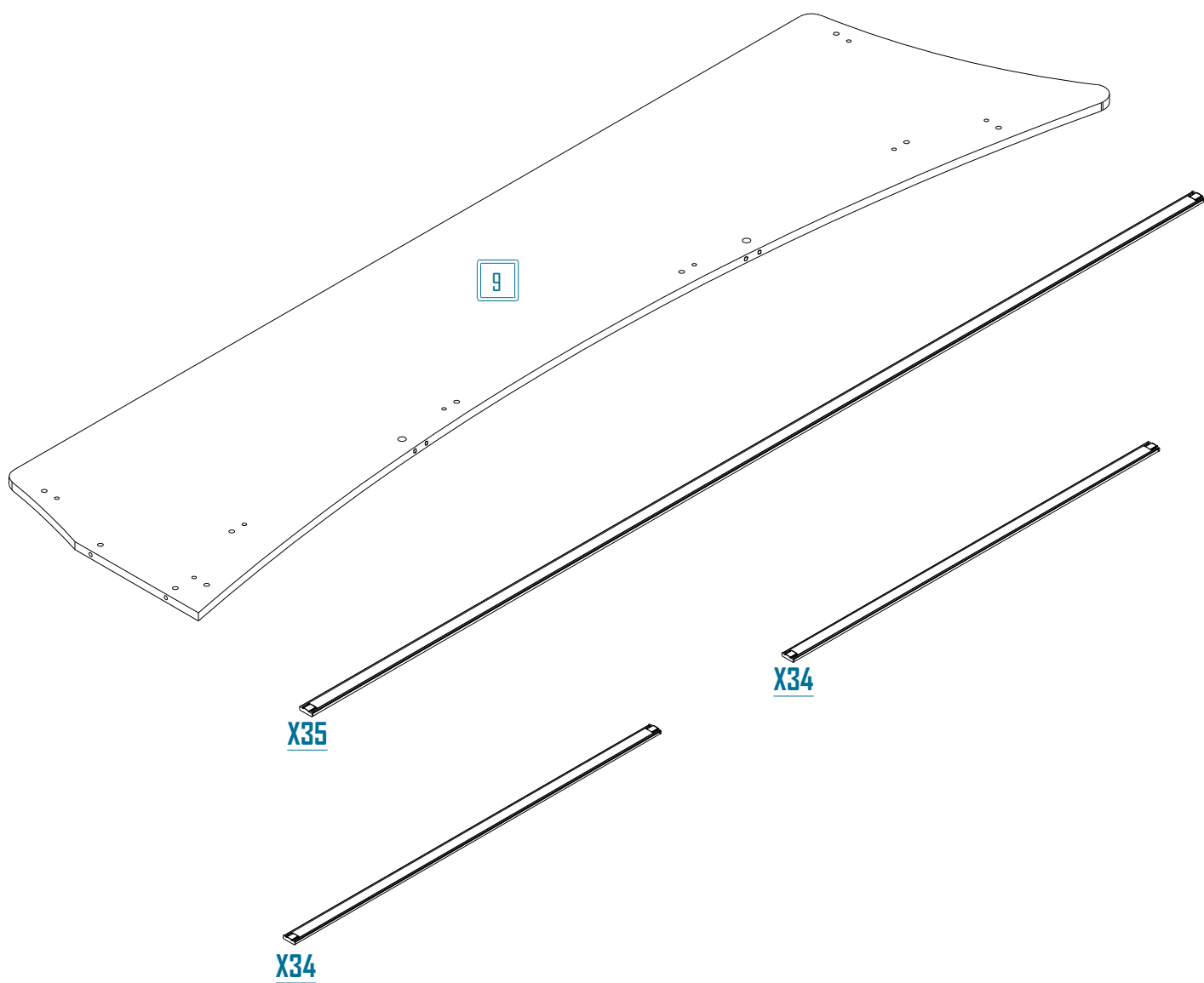

## Step / Adım - 1

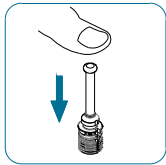

**A6 x 4**

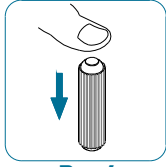

**D x 4**

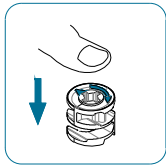

**B x 11**

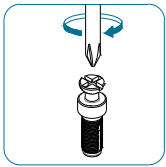

**EA1 x 8**

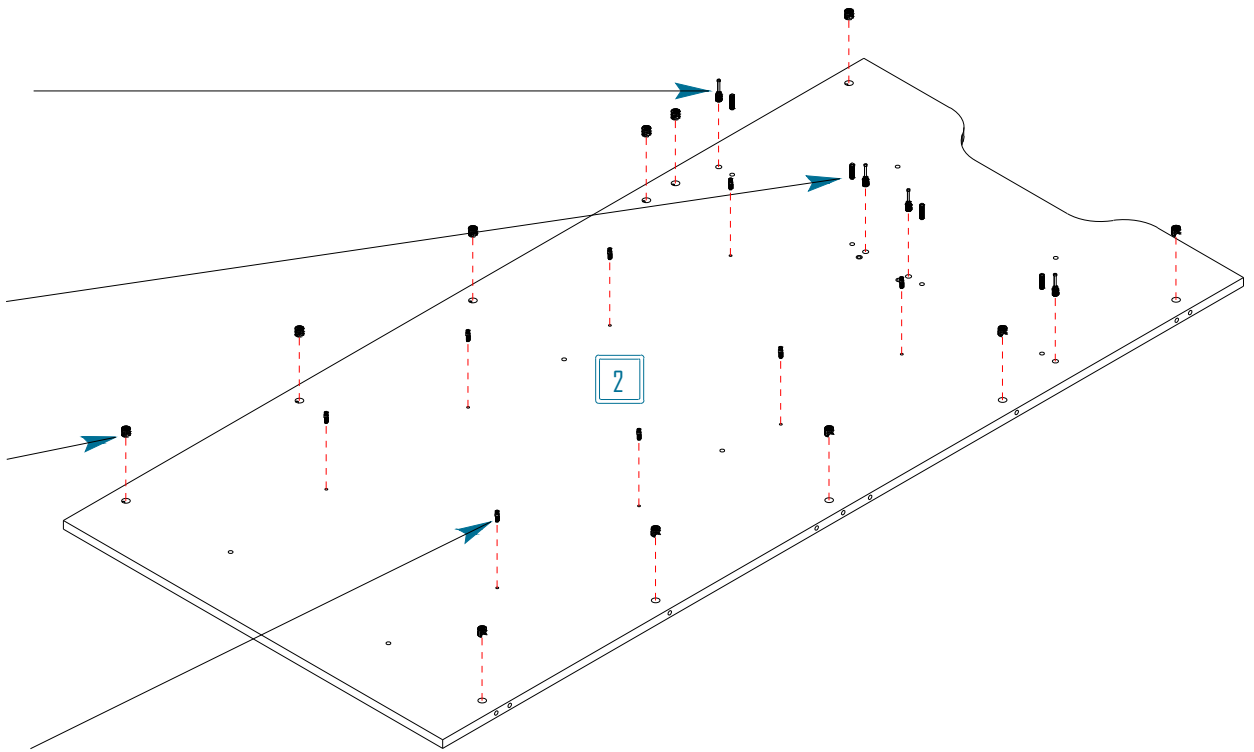

## Step / Adım - 2

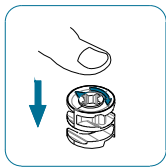

**B x 18**

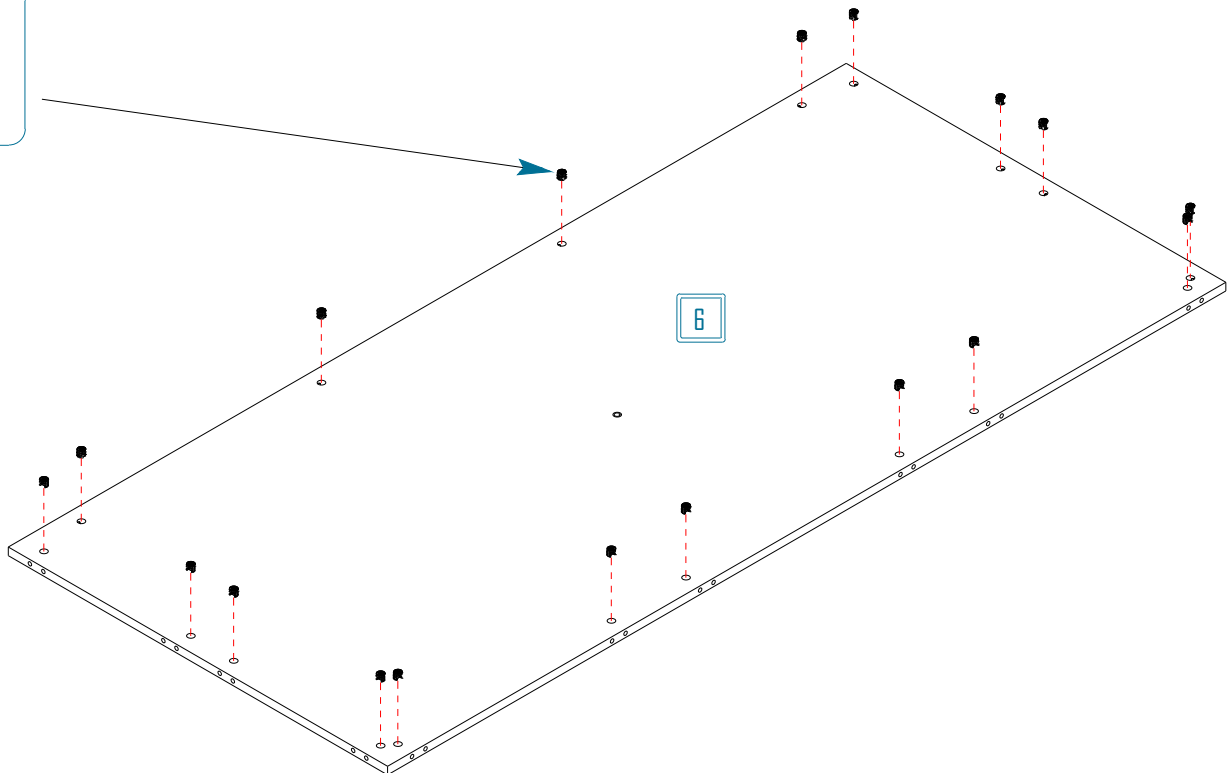

**Step / Adım - 3**

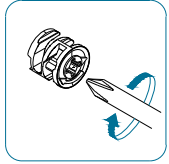

**B x 4**

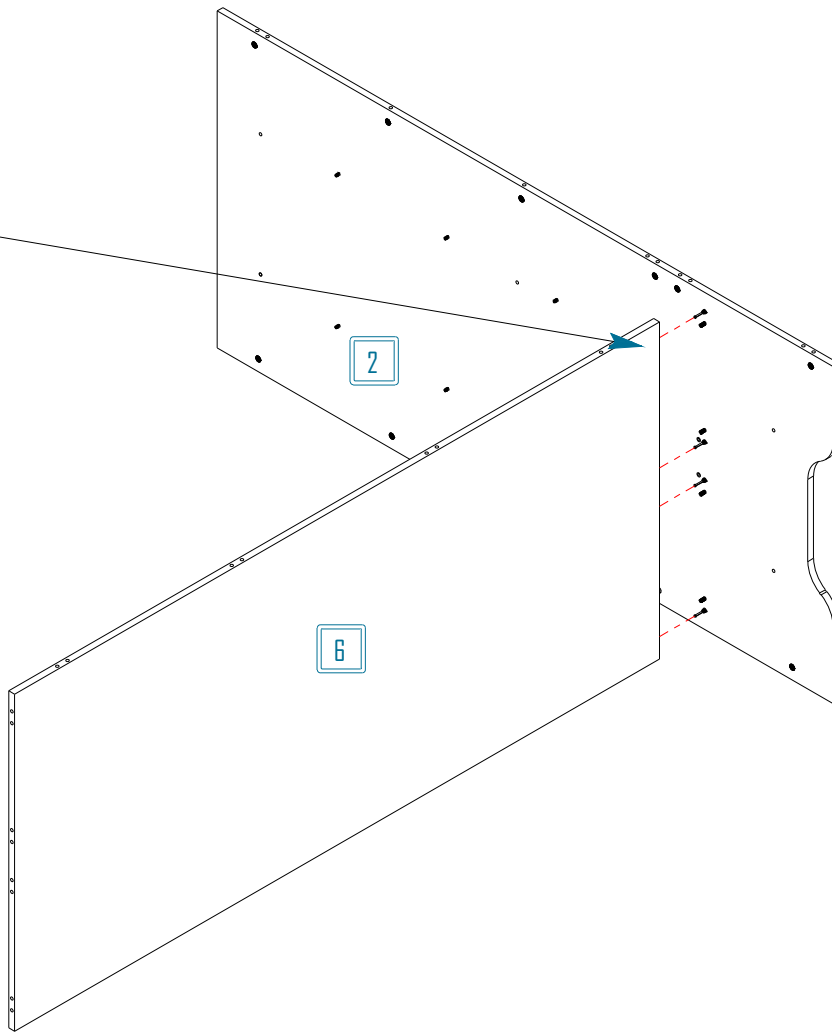

**Step / Adım - 4**

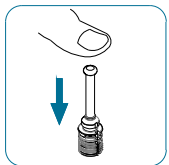

**A6 x 6**

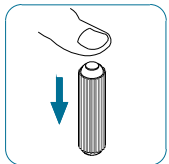

**D x 6**

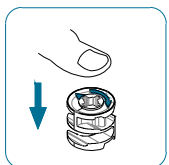

**B x 10**

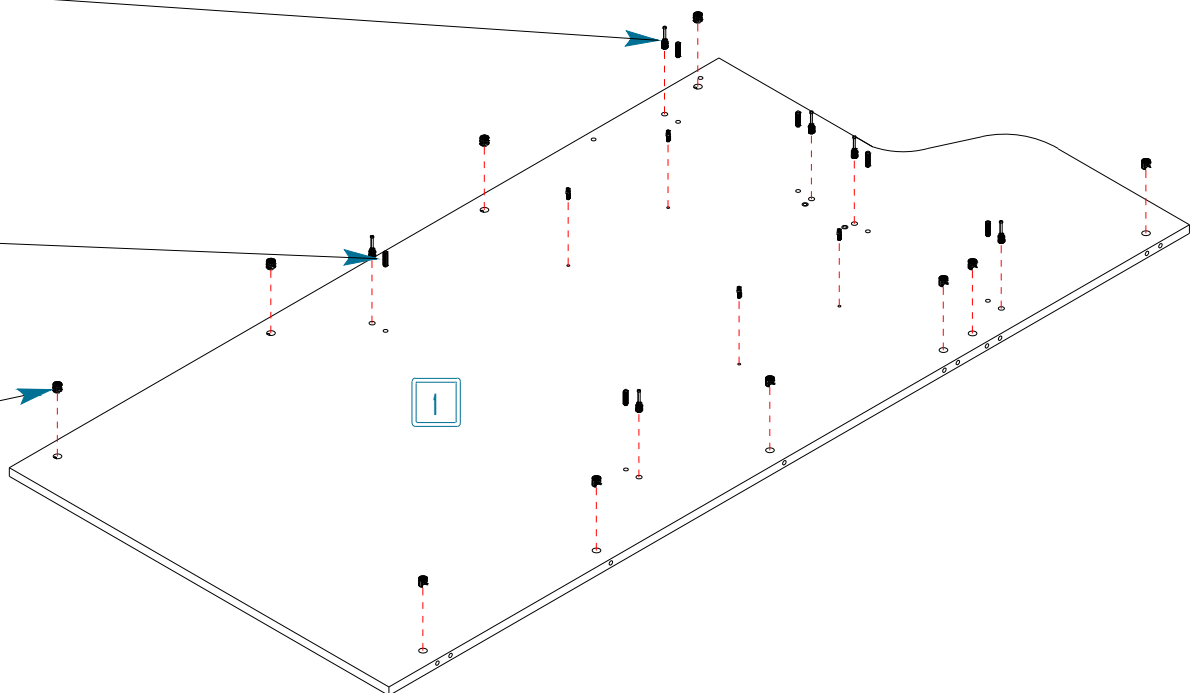

**Step / Adım - 5**

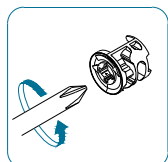

**B x 4**

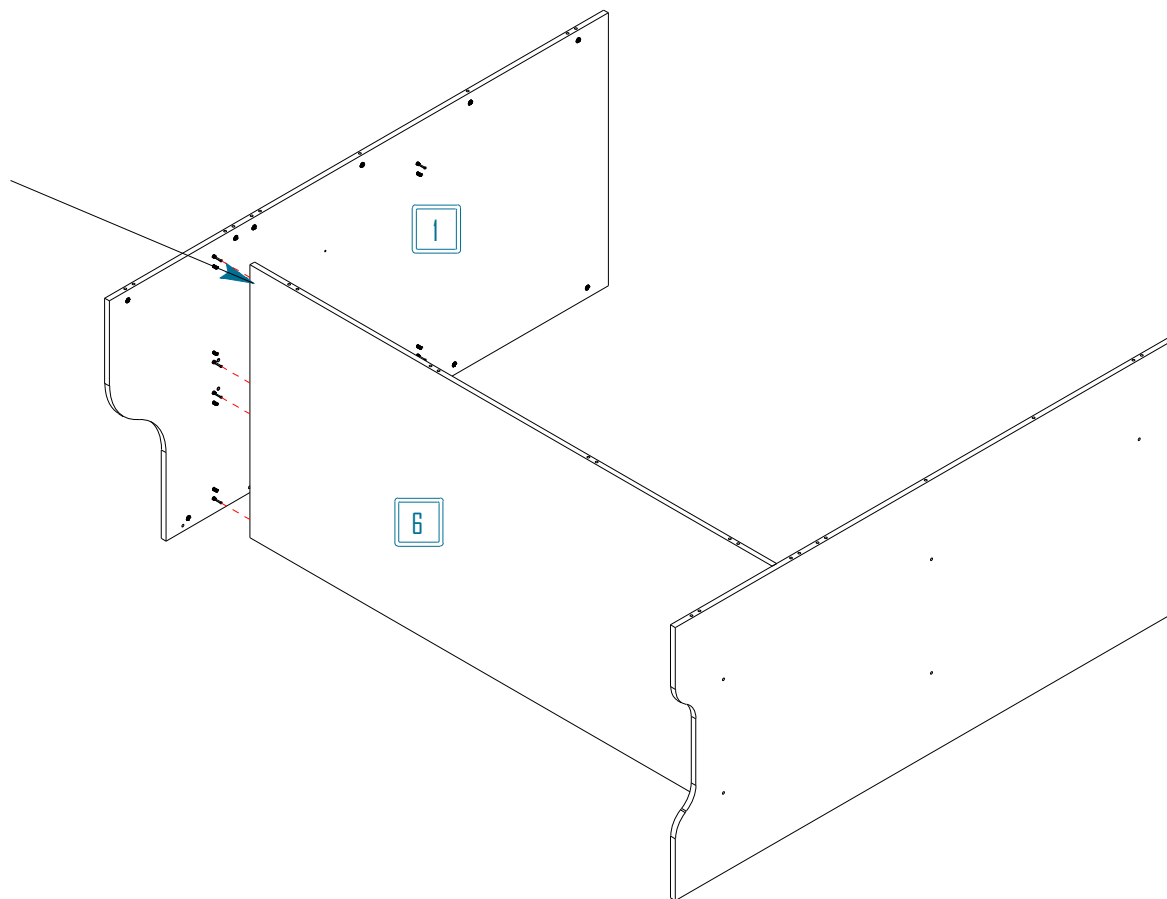

**Step / Adım - 6**

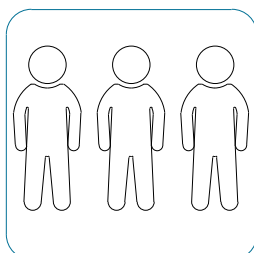
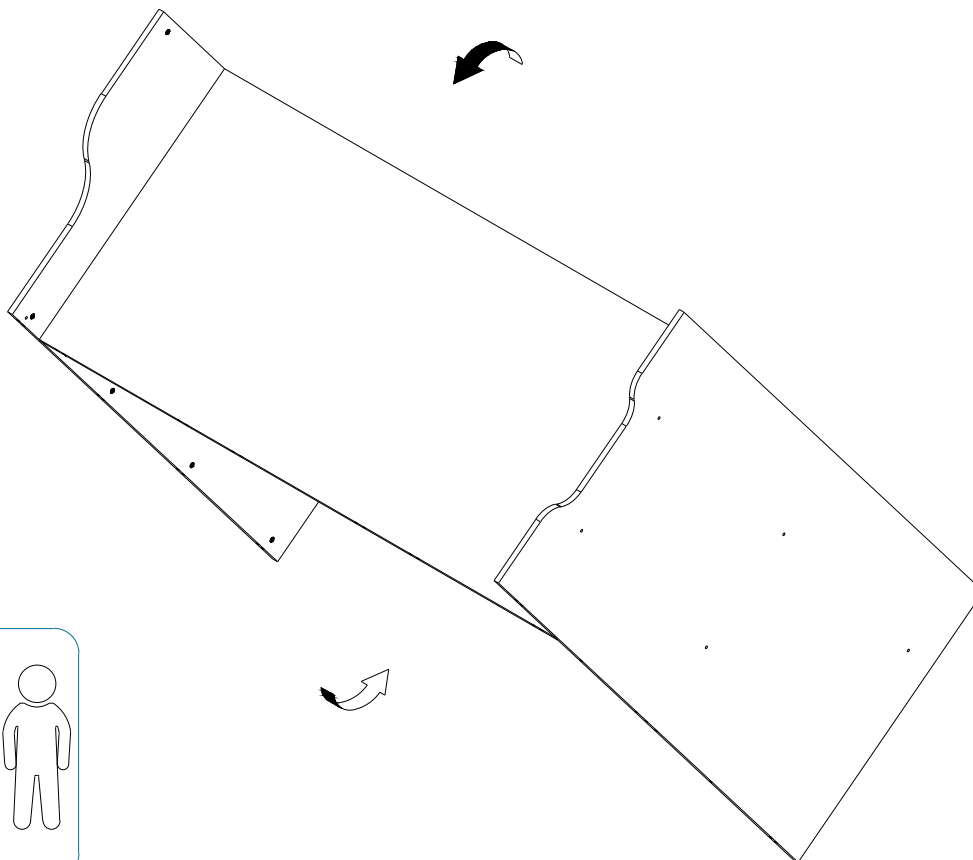

**Step / Adım - 7**

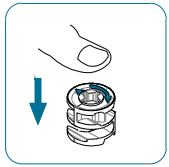

**B x 6**

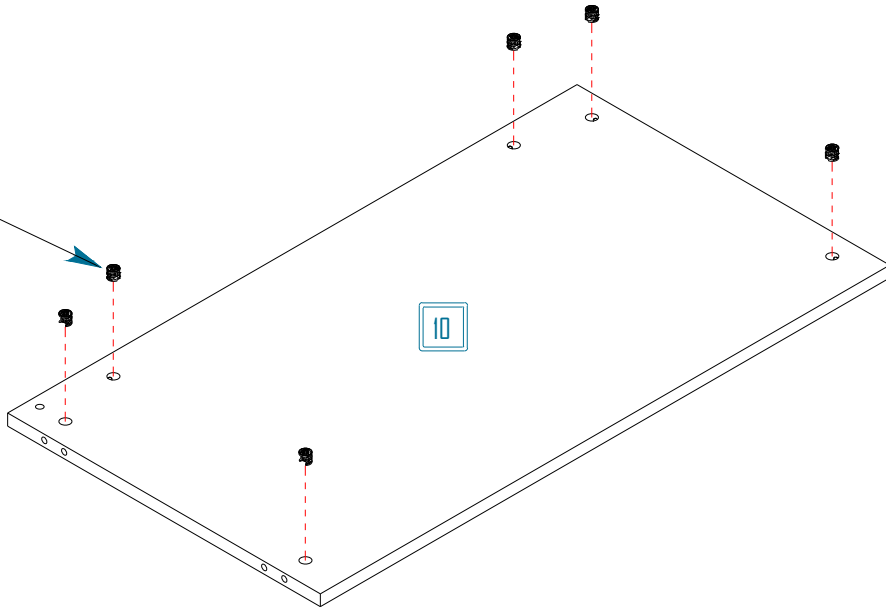

**Step / Adım - 8**

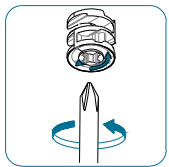

**B x 2**

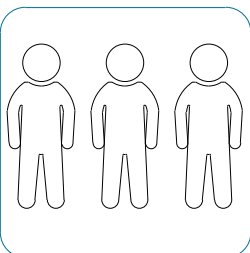
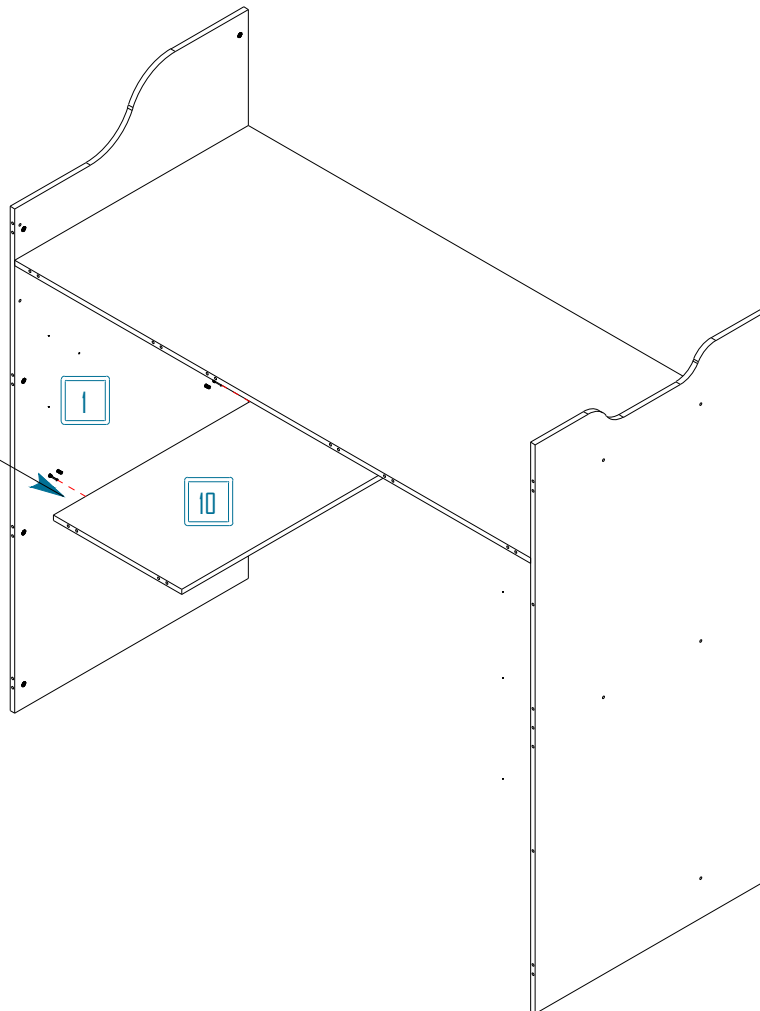



### Step / Adım - 9

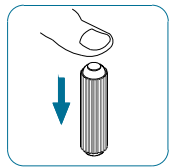

**D x 9**

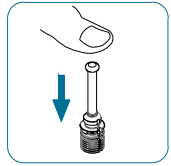

**A6 x 9**

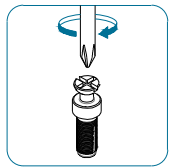

**EAI x 2**

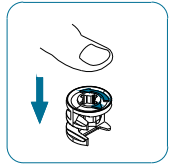

**B x 5**

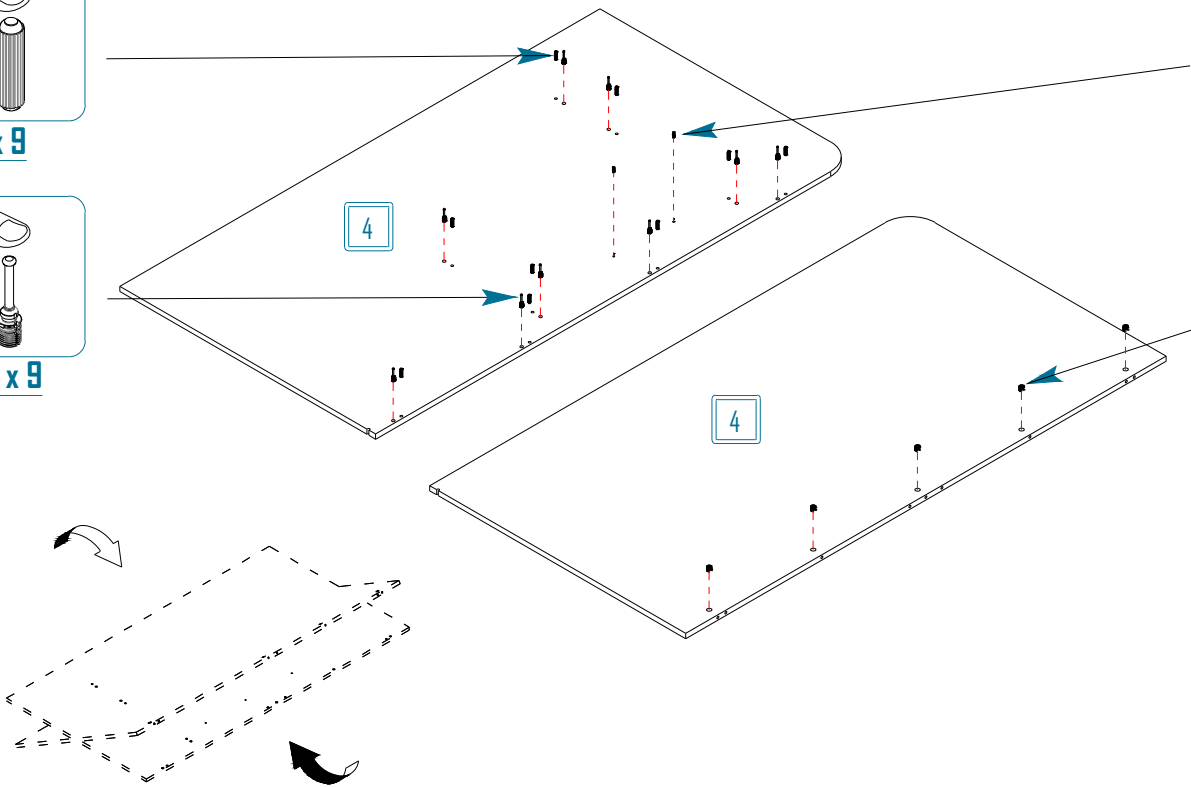

### Step / Adım - 10

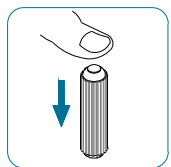

**D x 9**

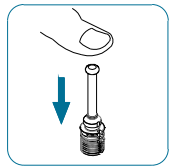

**A6 x 8**

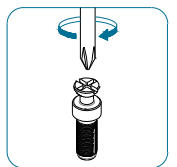

**EAI x 3**

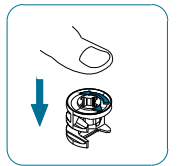

**B x 5**

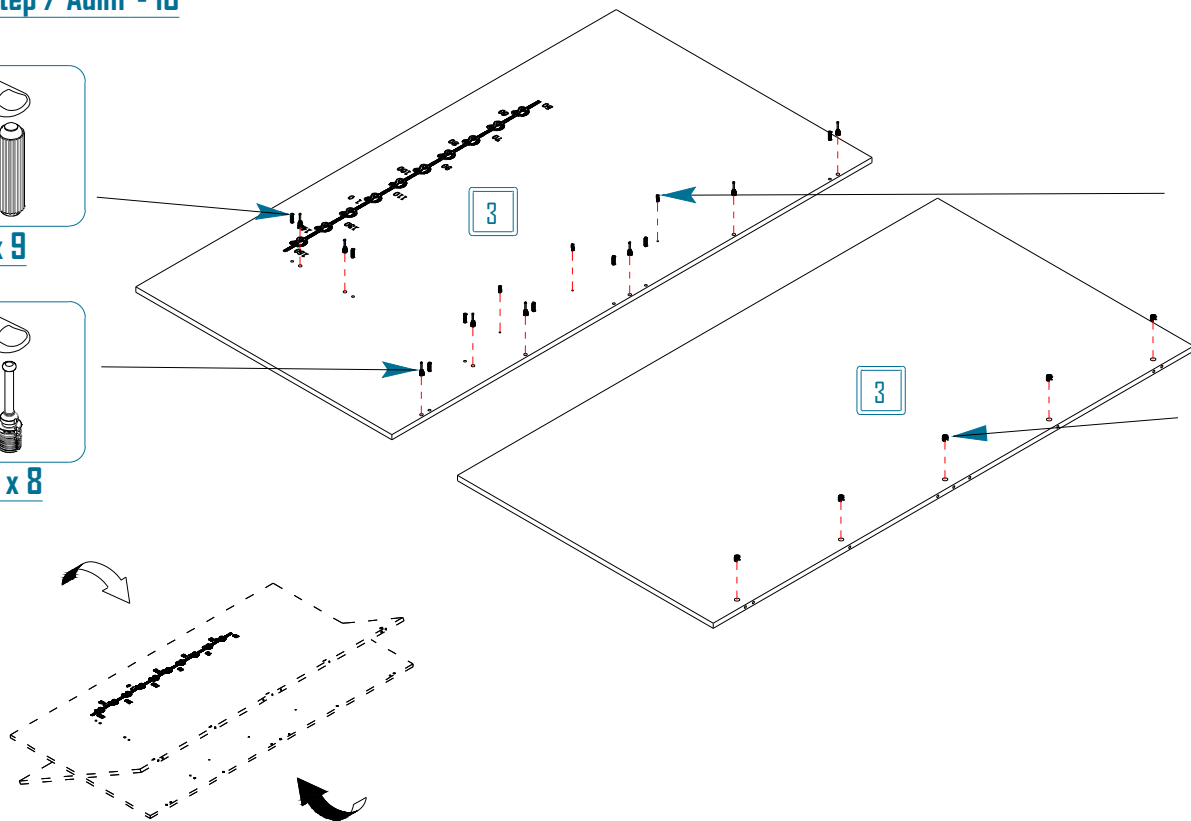

**Step / Adım - 11**

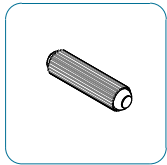

**D x 4**

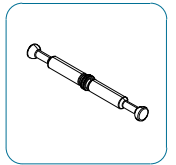

**A2 x 5**

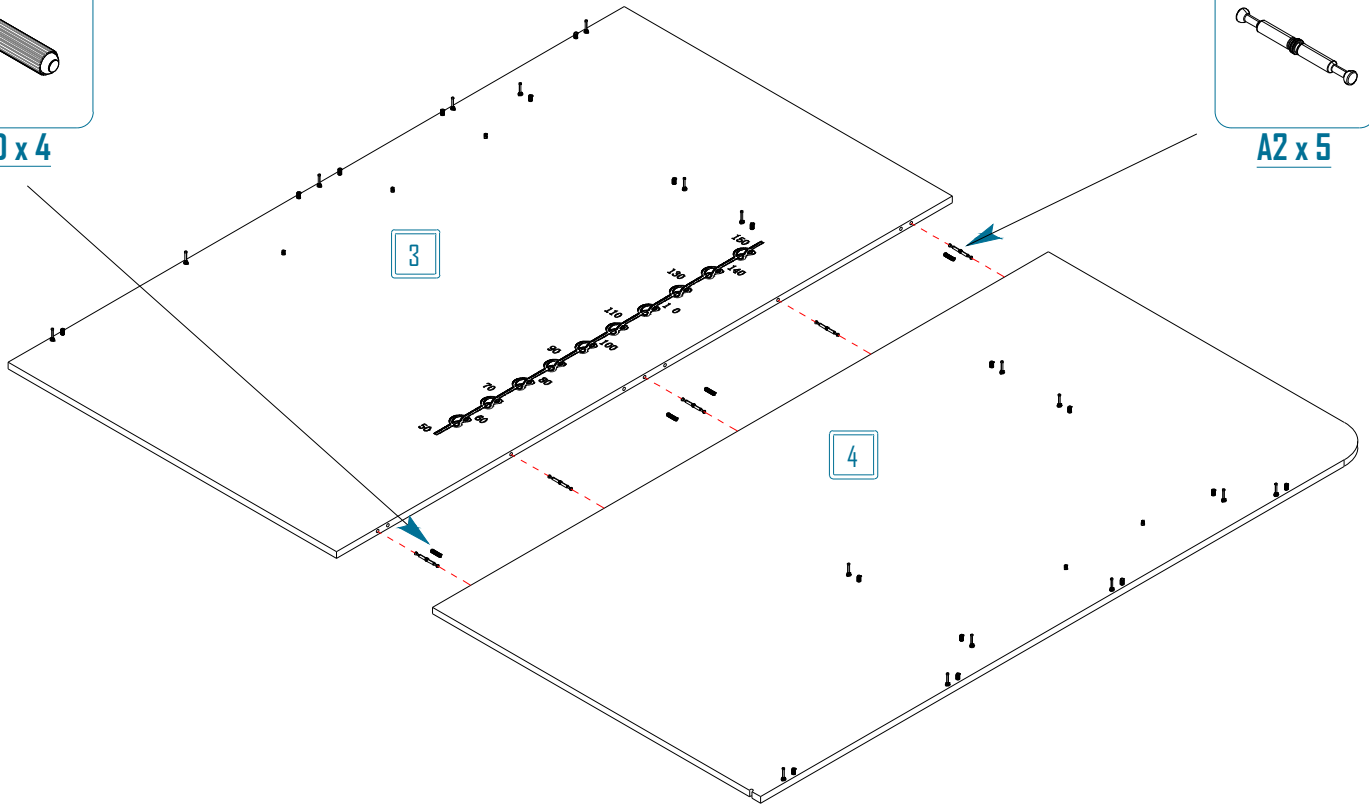

**Step / Adım - 12**

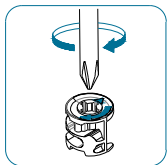

**B x 17**

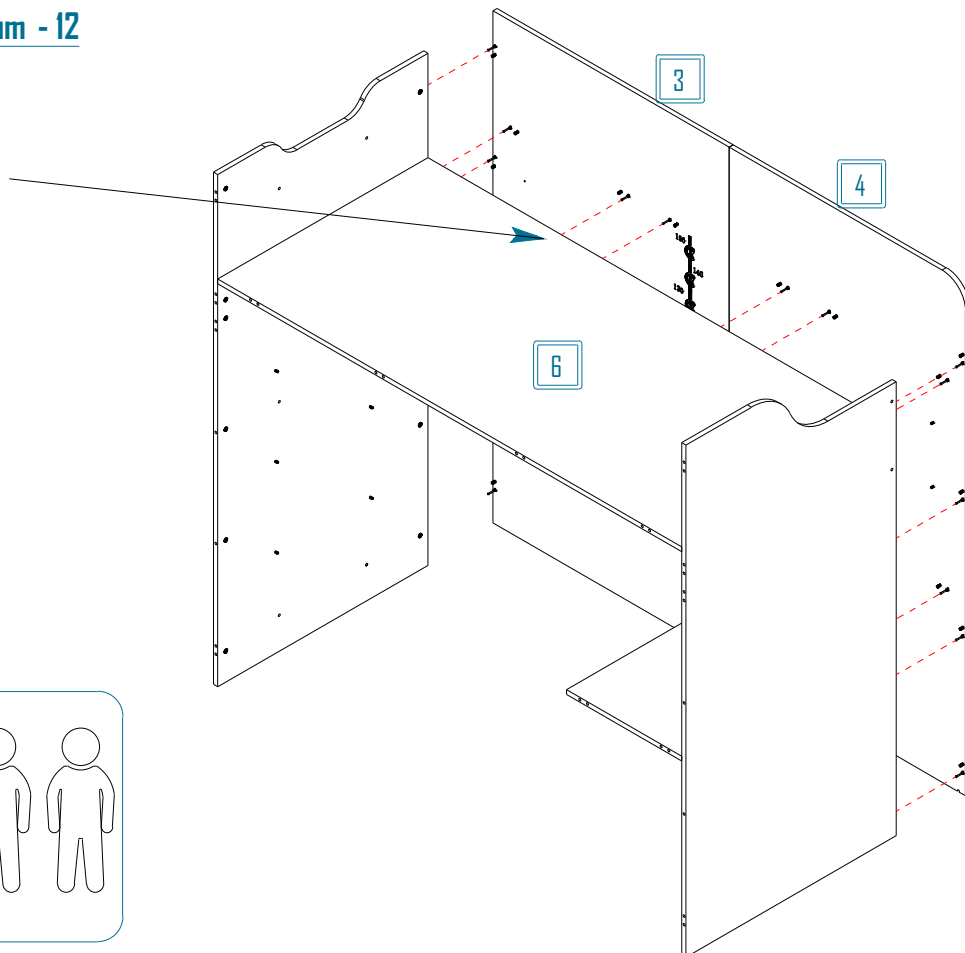
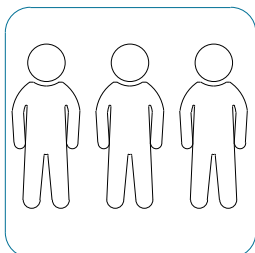

**Step / Adım - 13**

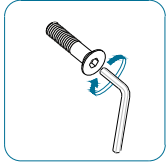

**13 x 4**

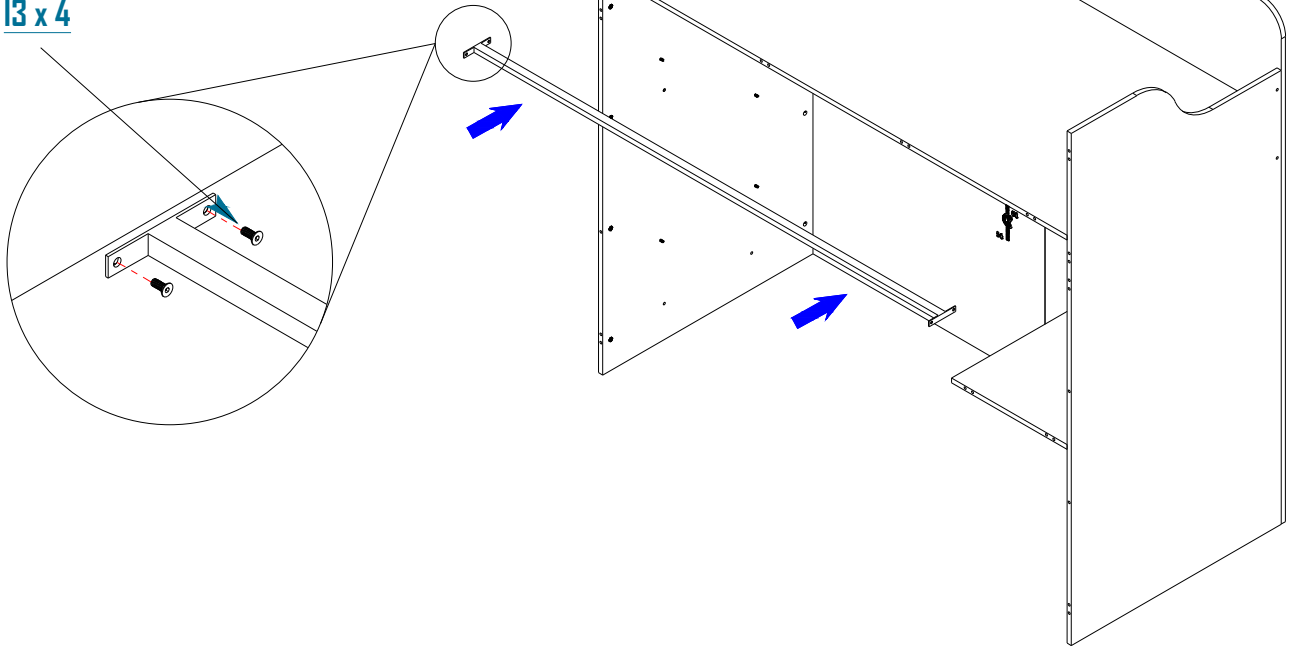

**Step / Adım - 14**

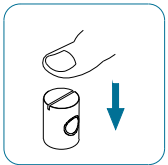

**X11 x 3**

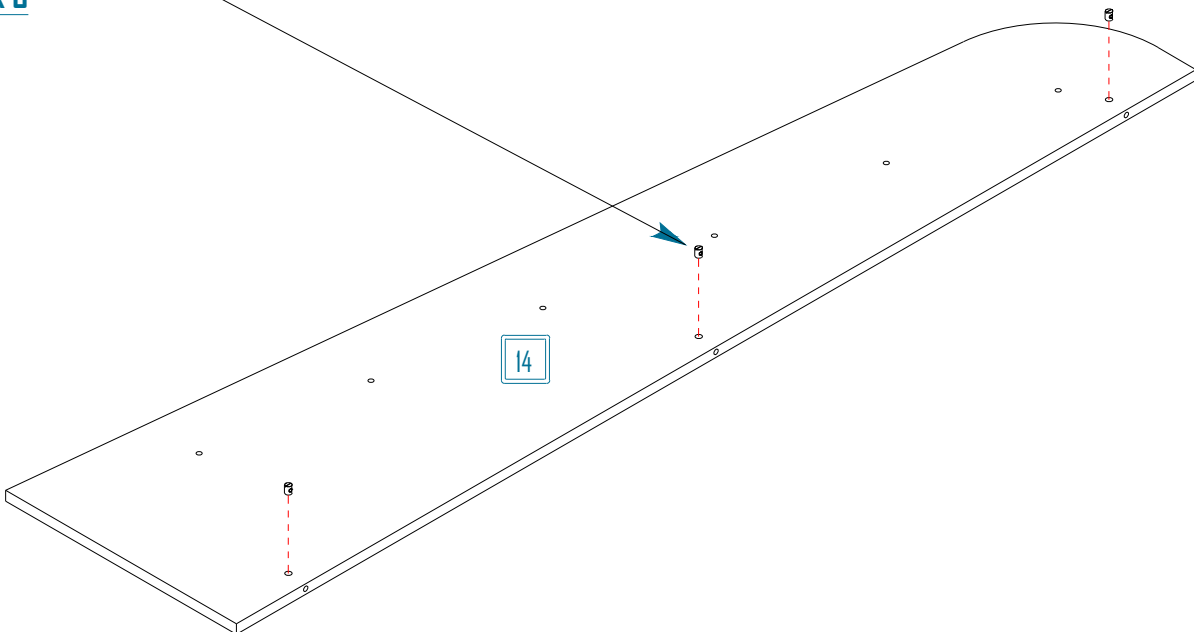

**Step / Adım - 15**

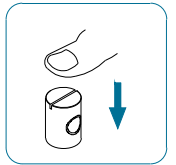
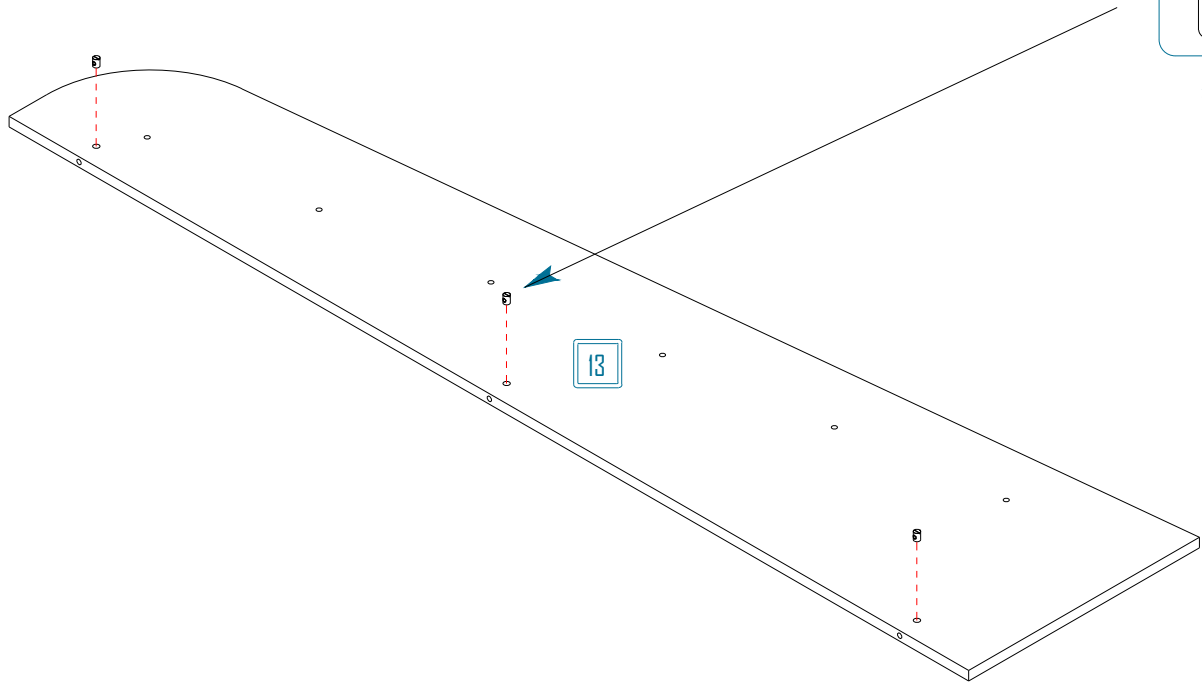

**X11 x 3**

**Step / Adım - 16**

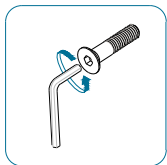

**19 x 6**

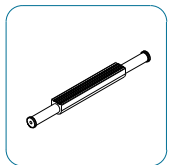
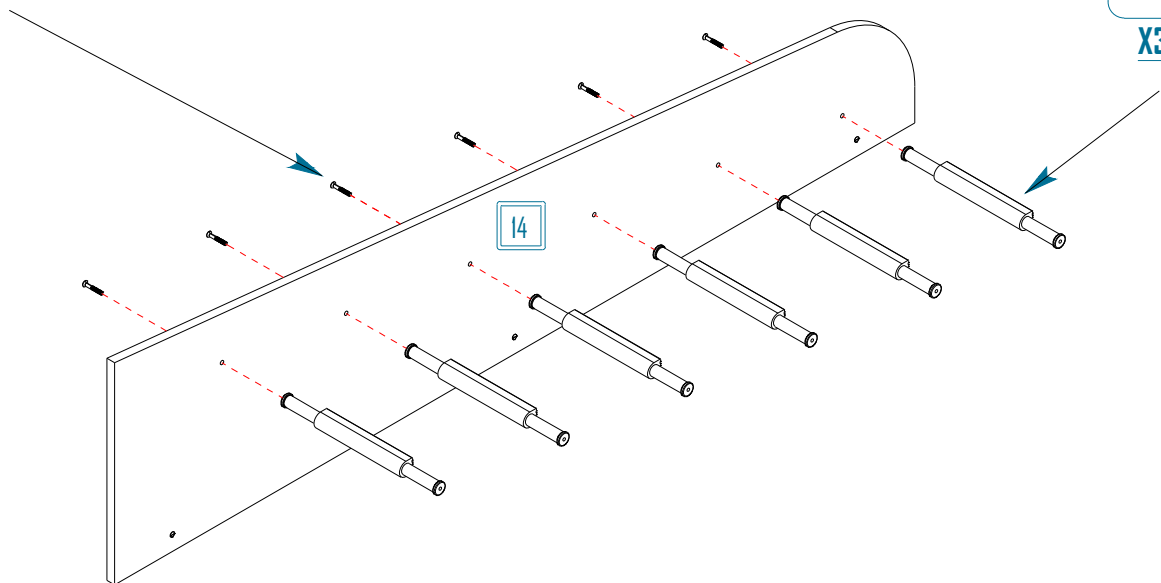

**X33 x 6**

**Step / Adım - 17**

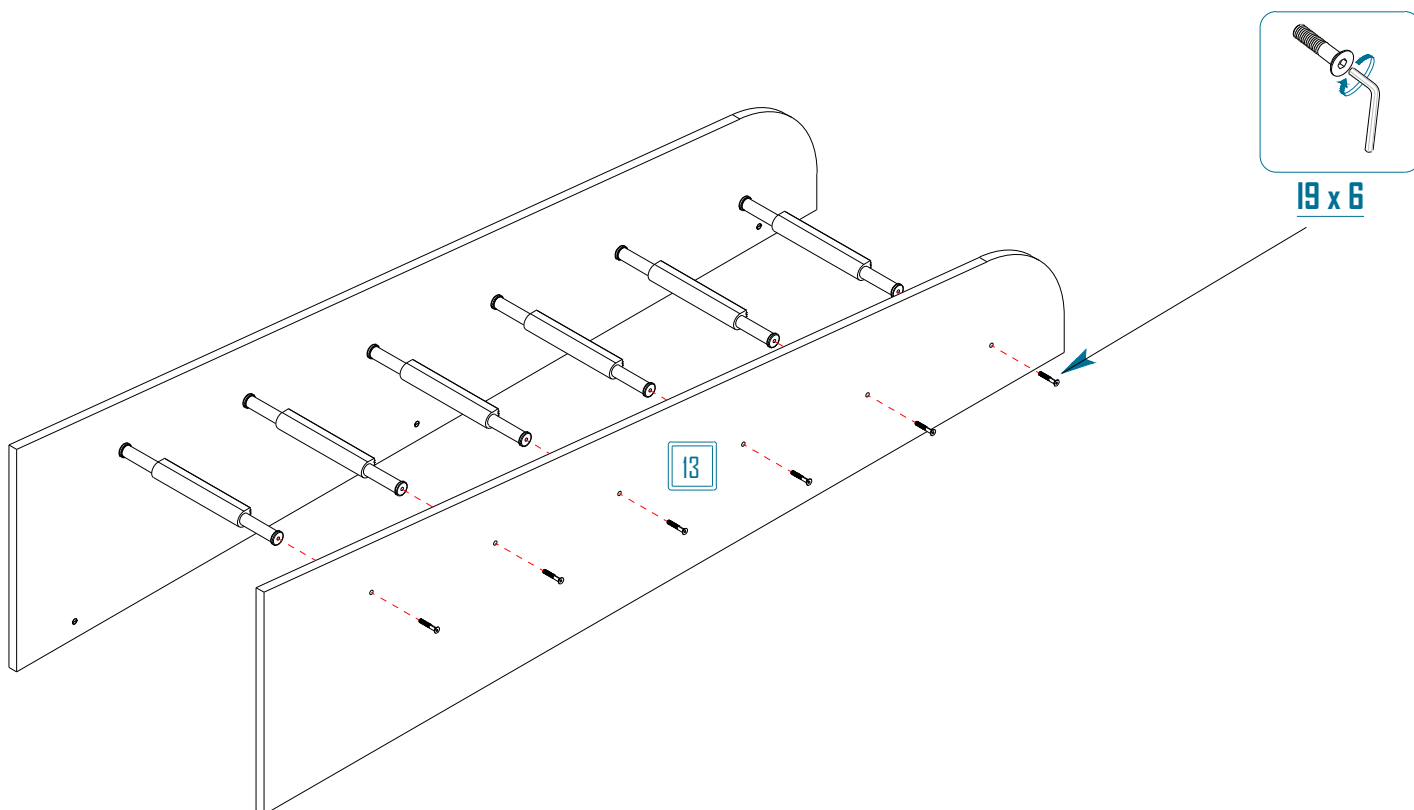

**Step / Adım - 18**

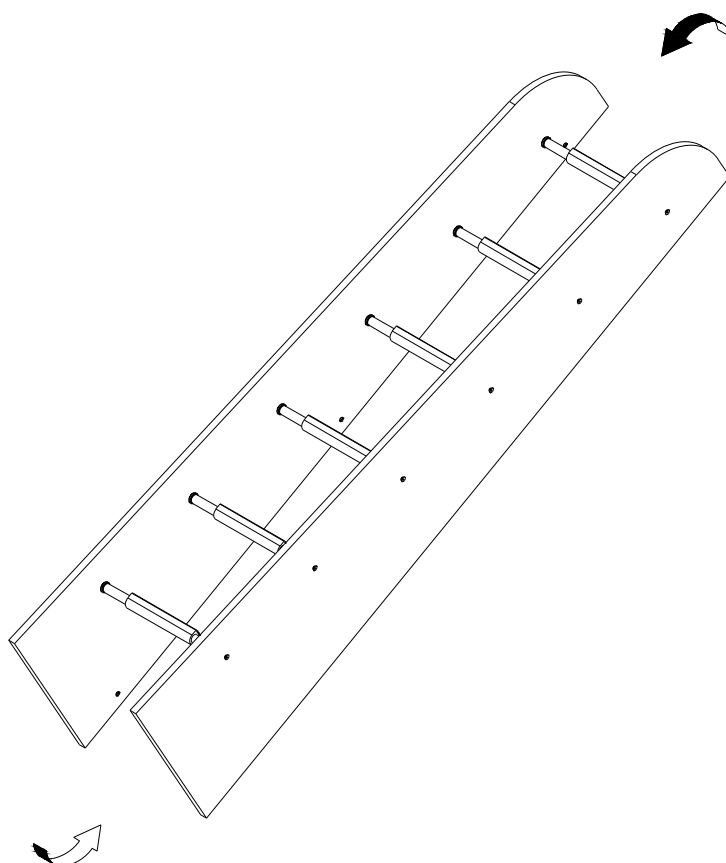

**Step / Adım - 19**

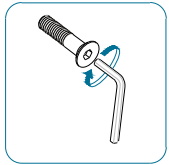

**19 x 6**

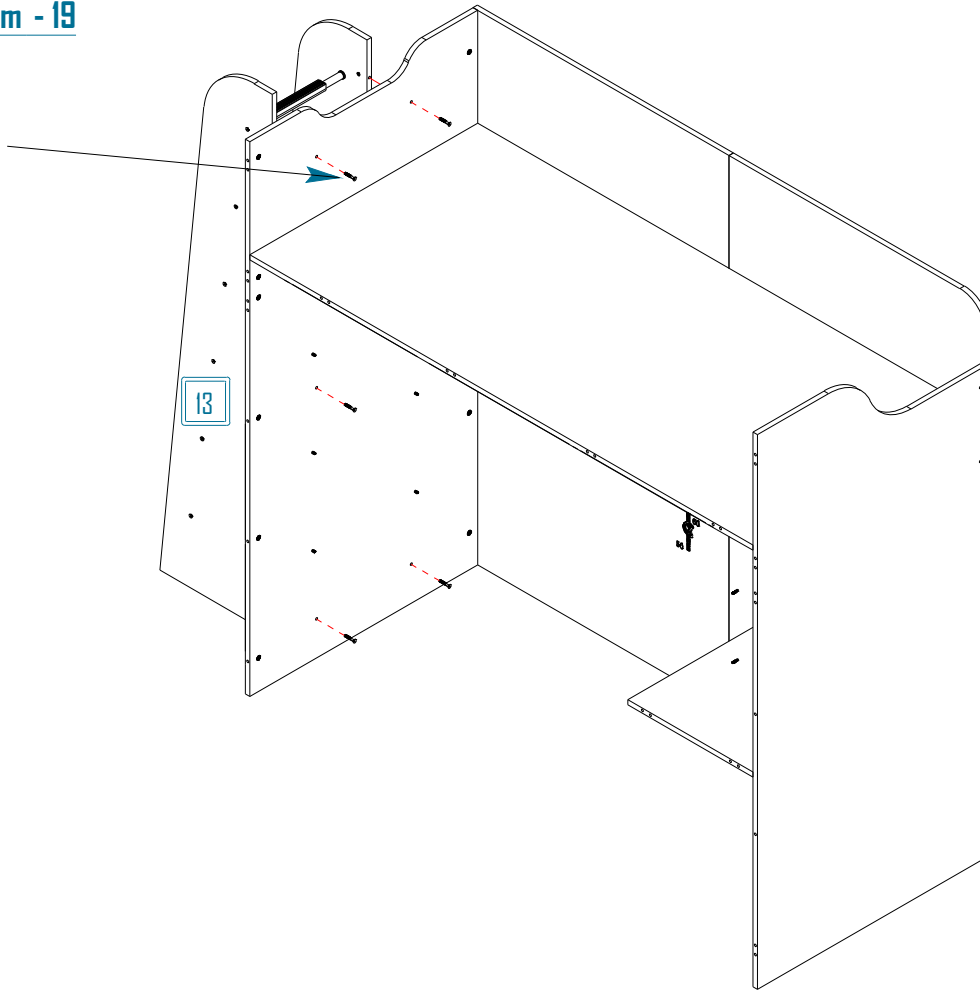

**Step / Adım - 20**

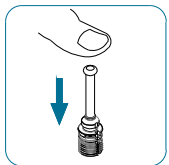

**A6 x 6**

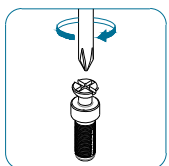

**E11 x 2**

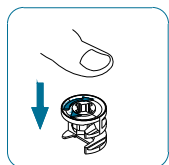

**B x 1**

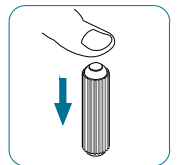

**D x 4**

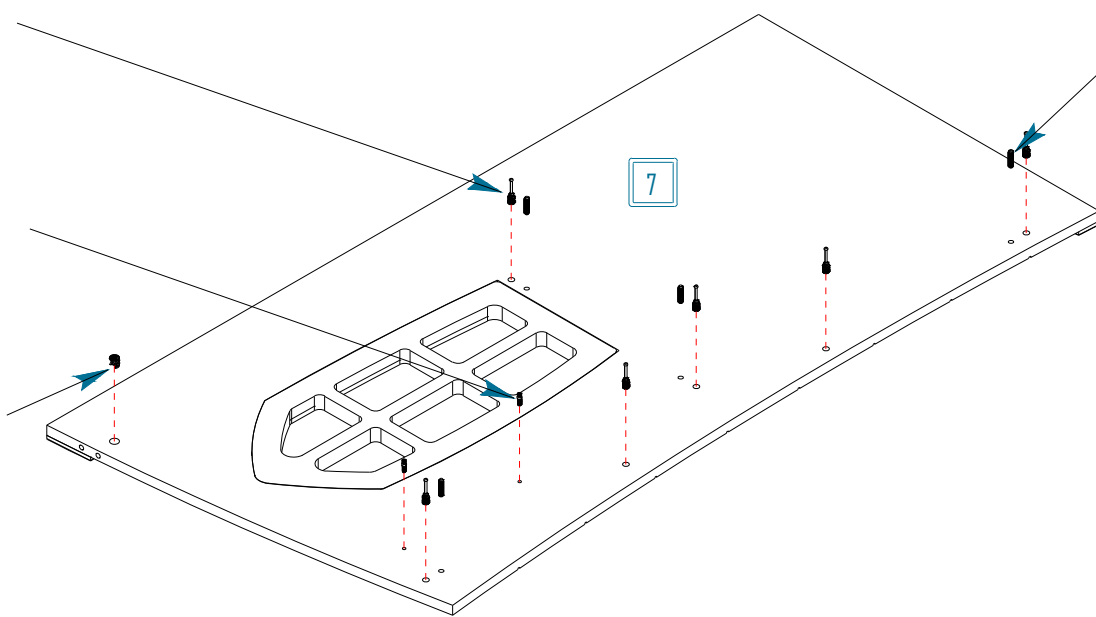

**Step / Adım - 21**

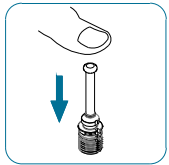

**A6 x 4**

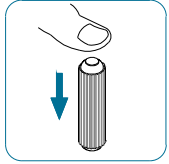

**D x 2**

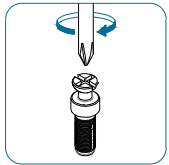

**EAI x 2**

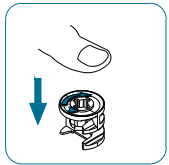

**B x 1**

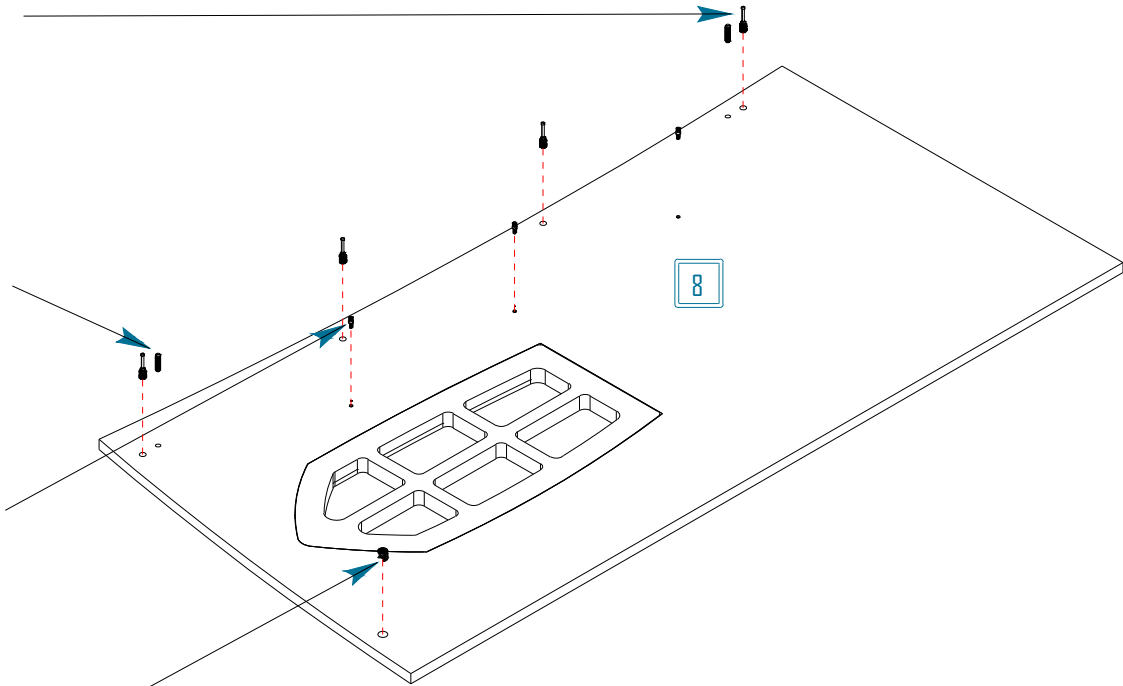

**Step / Adım - 22**

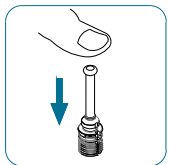

**A6 x 8**

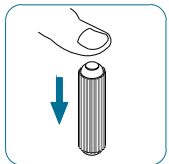

**D x 8**

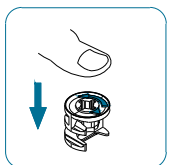

**B x 2**

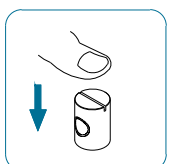

**XII x 2**

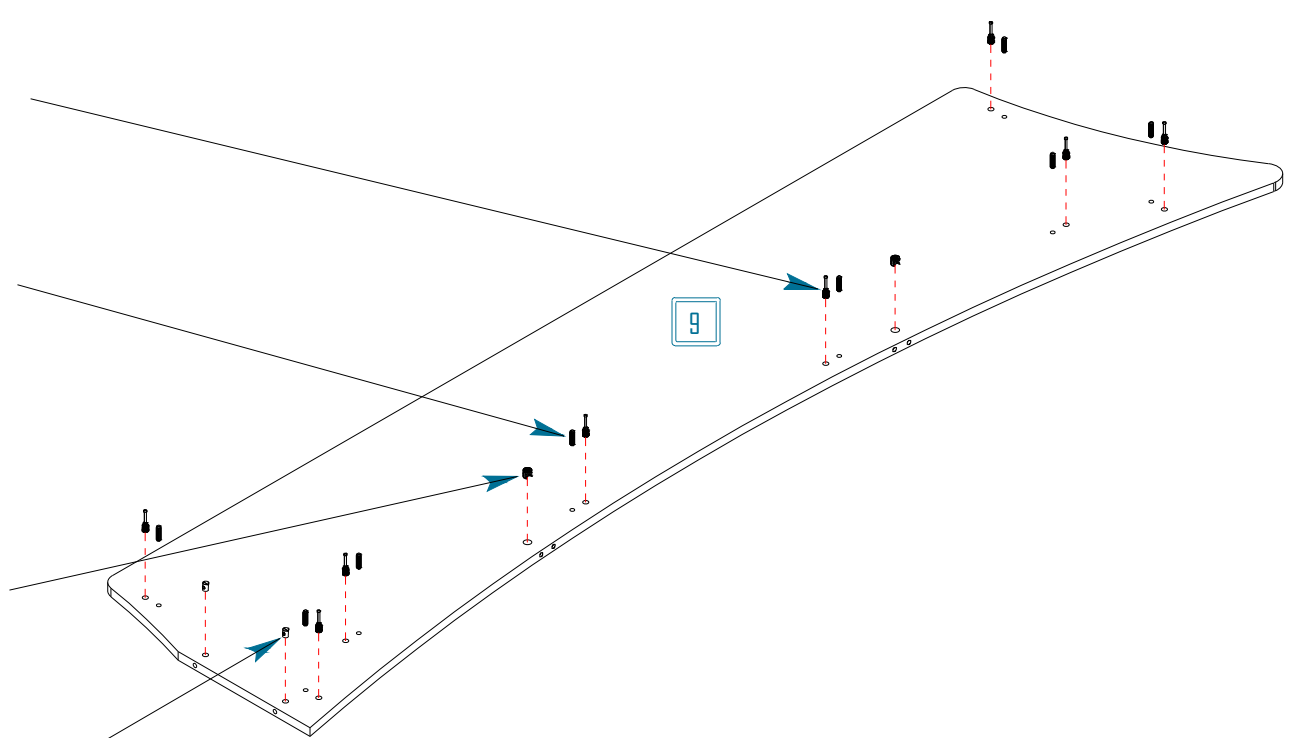

### Step / Adım - 23

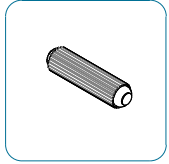

D x 2

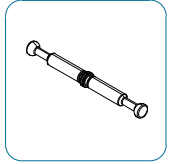

A2 x 2

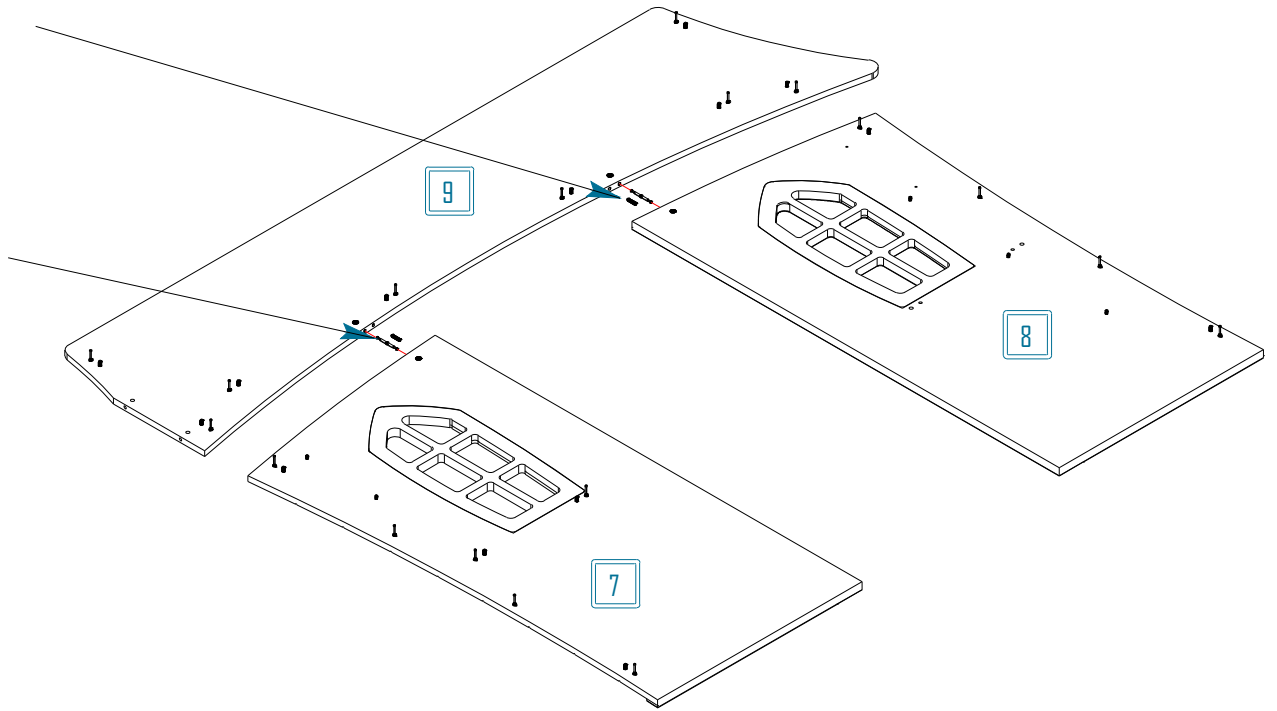

### Step / Adım - 24

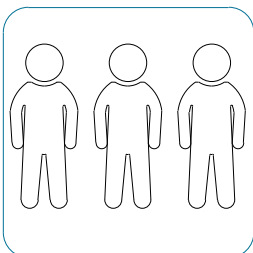
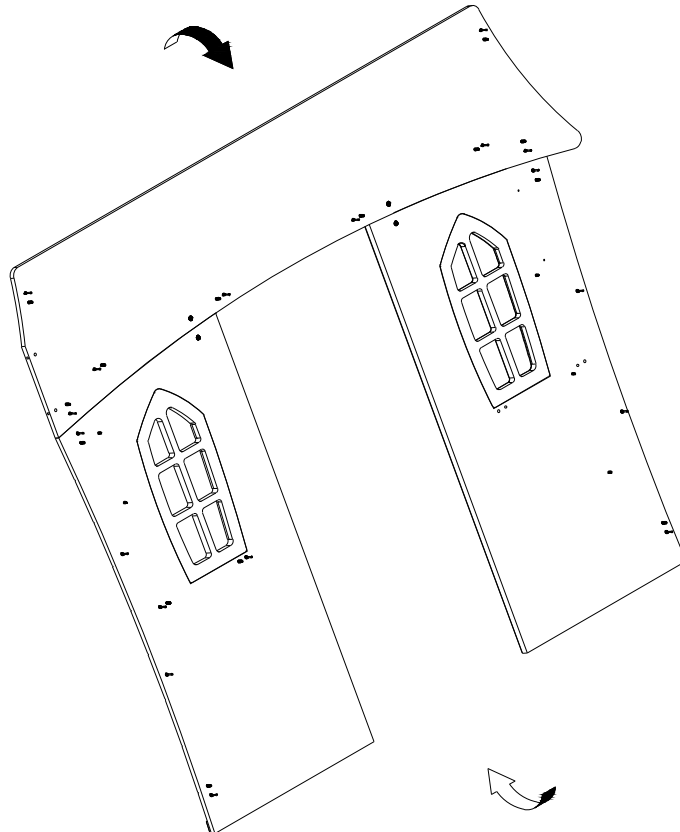



**Step / Adım - 25**

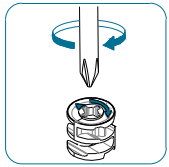

**B x 18**

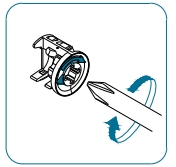

**B x 10**

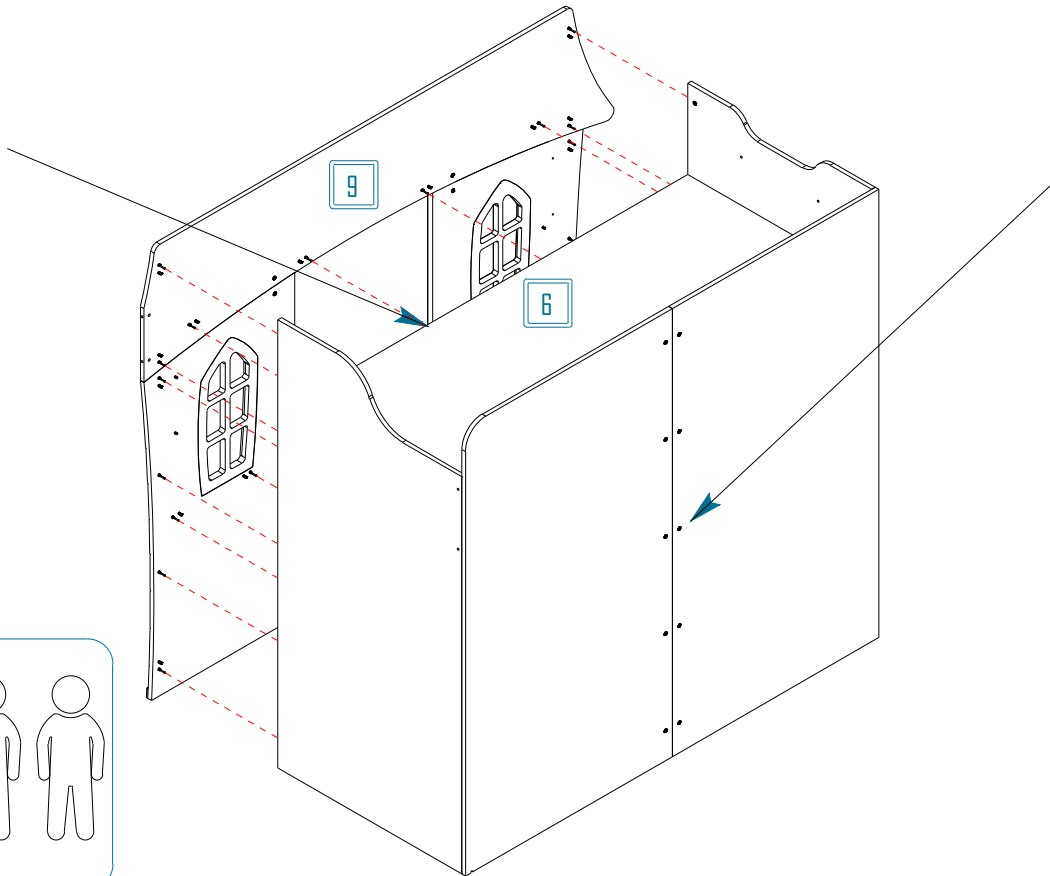
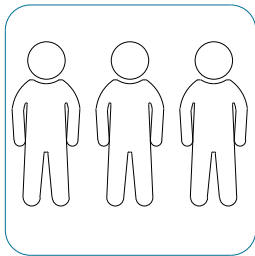

**Step / Adım - 26**

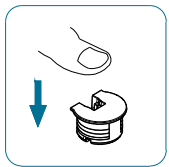

**Ex 4**

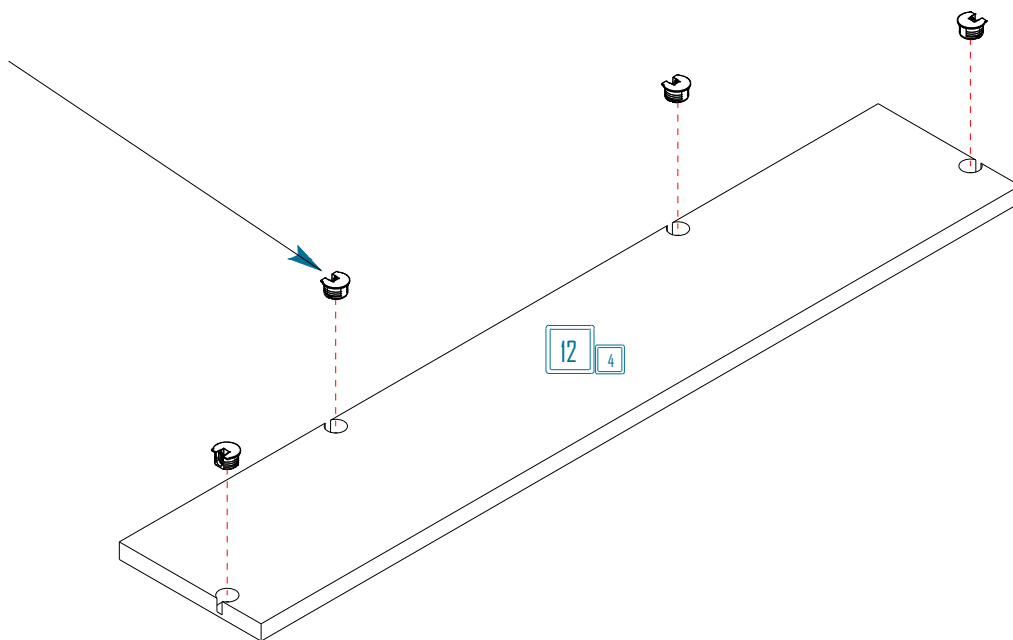

**Step / Adım - 27**

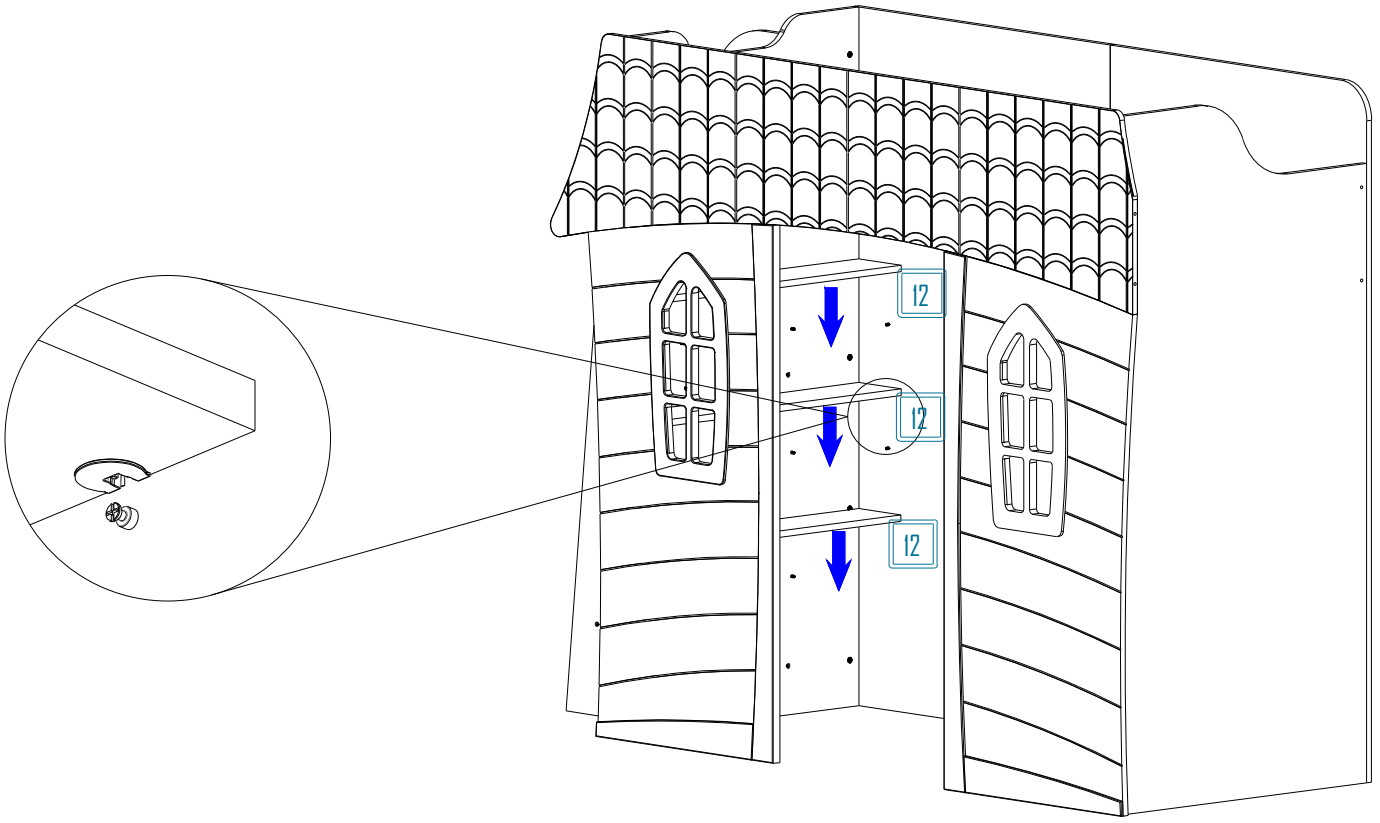

**Step / Adım - 28**

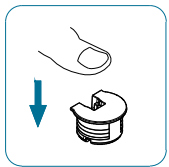

**E x 4**

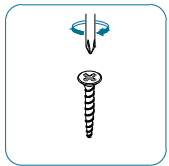

**J8 x 2**

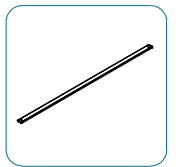

**X34 x 1**

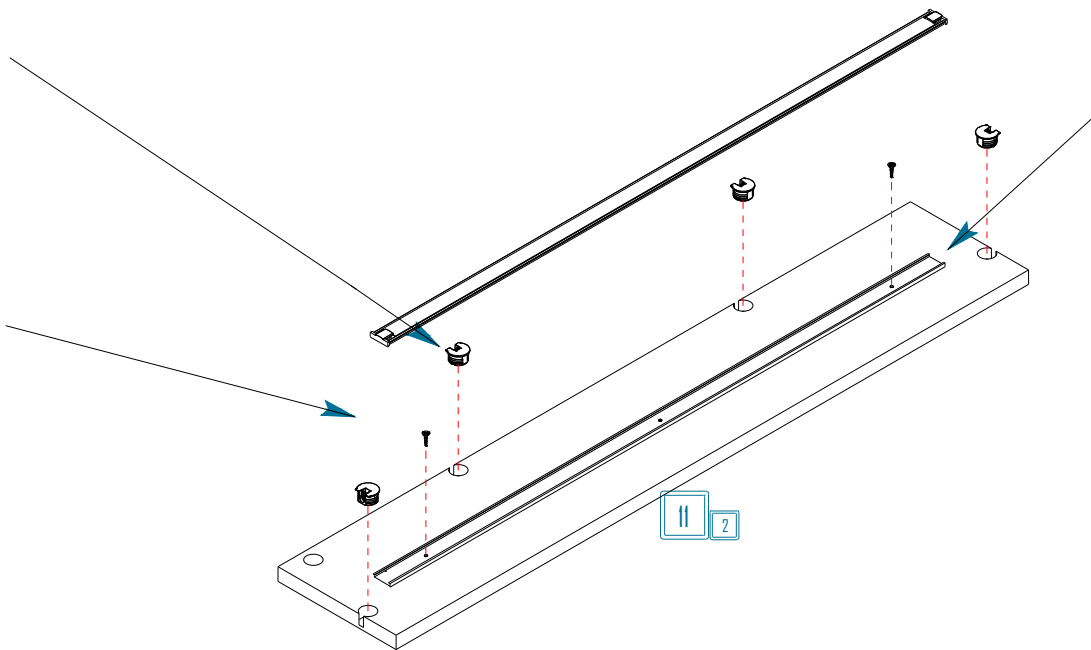

**Step / Adım - 29**

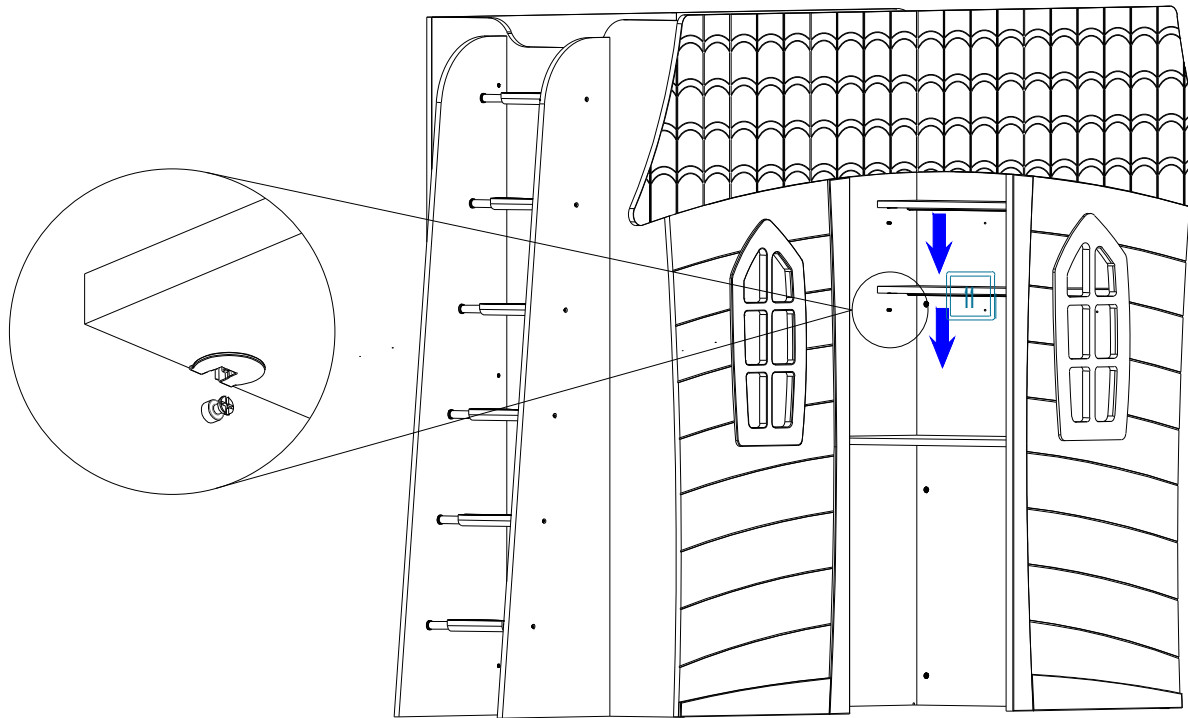

**Step / Adım - 30**

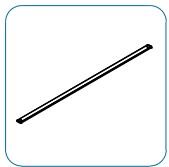

**X35 x 1**

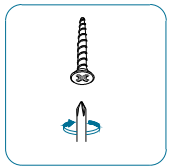

**J8 x 4**

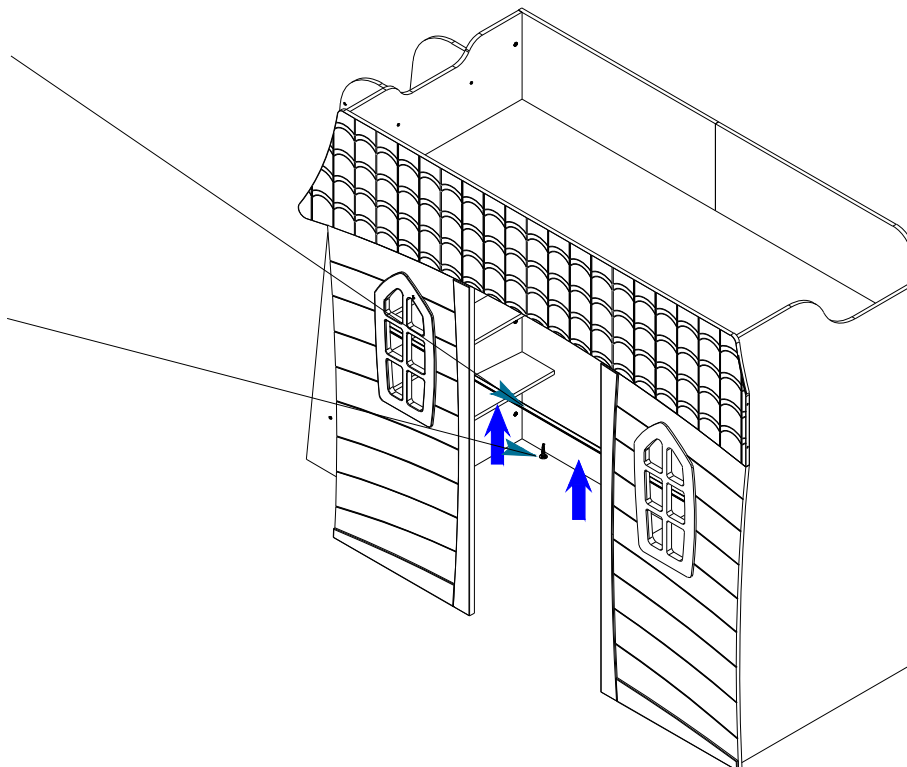

**Step / Adım - 31**

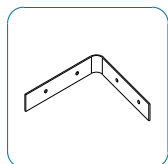

**X33 x 2**

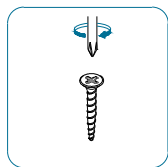

**J8 x 4**

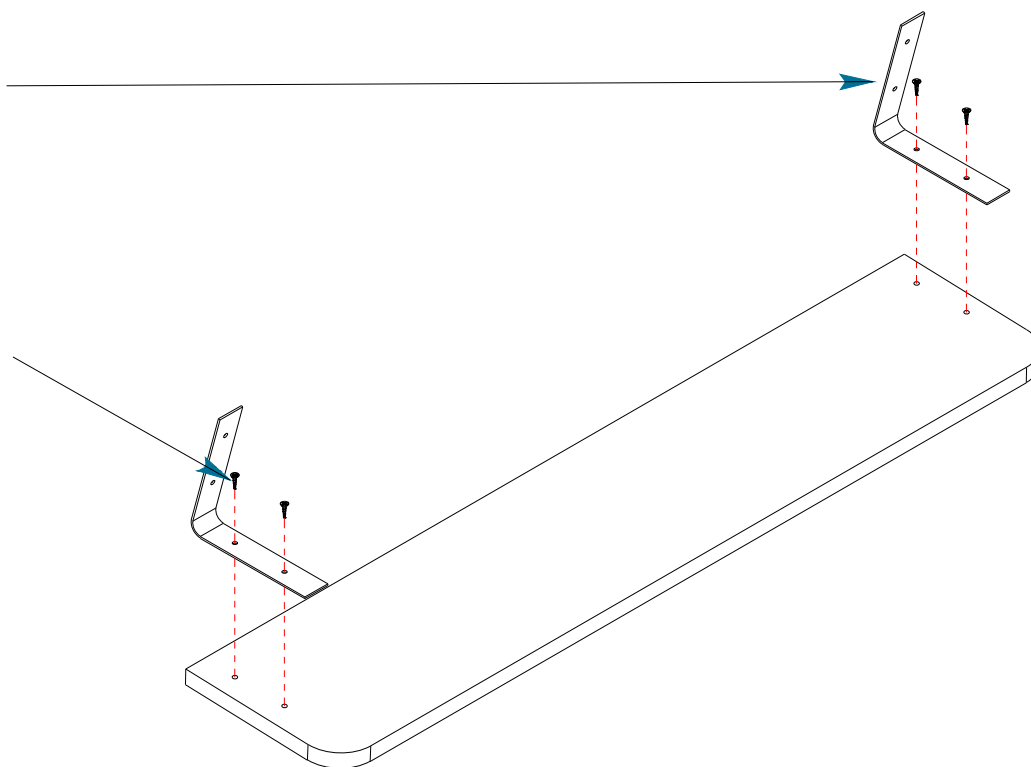

**Step / Adım - 32**

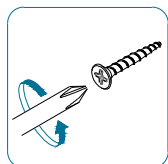

**J8 x 4**

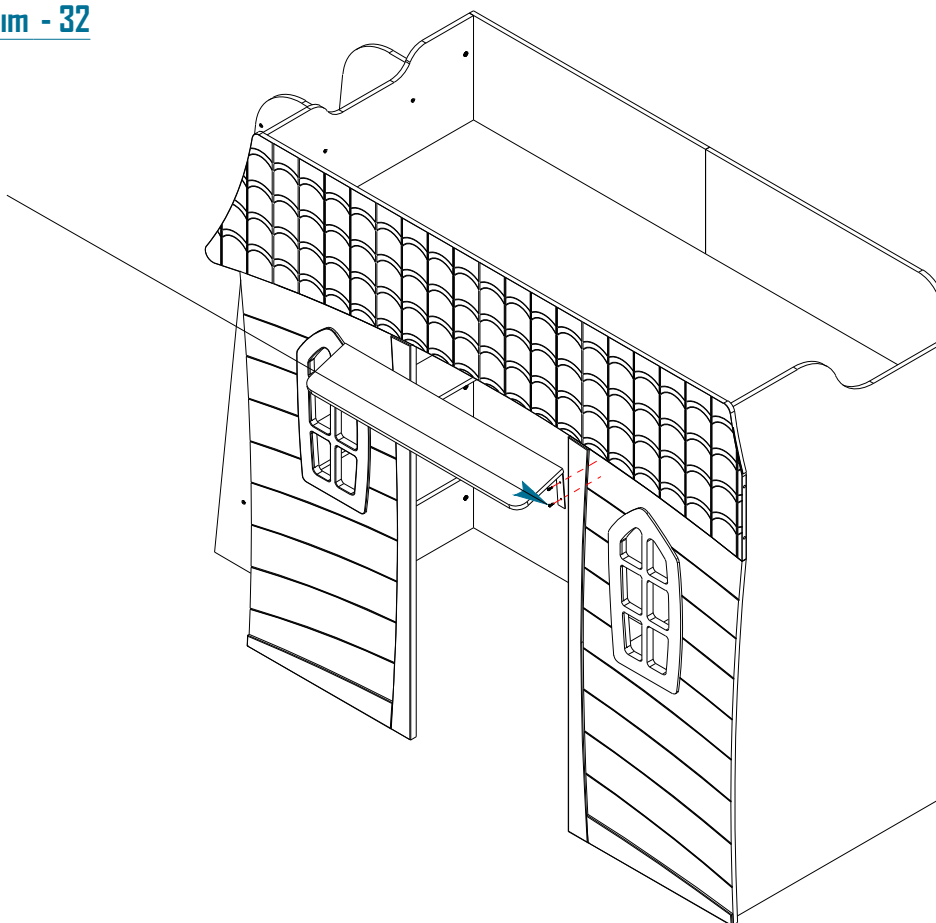

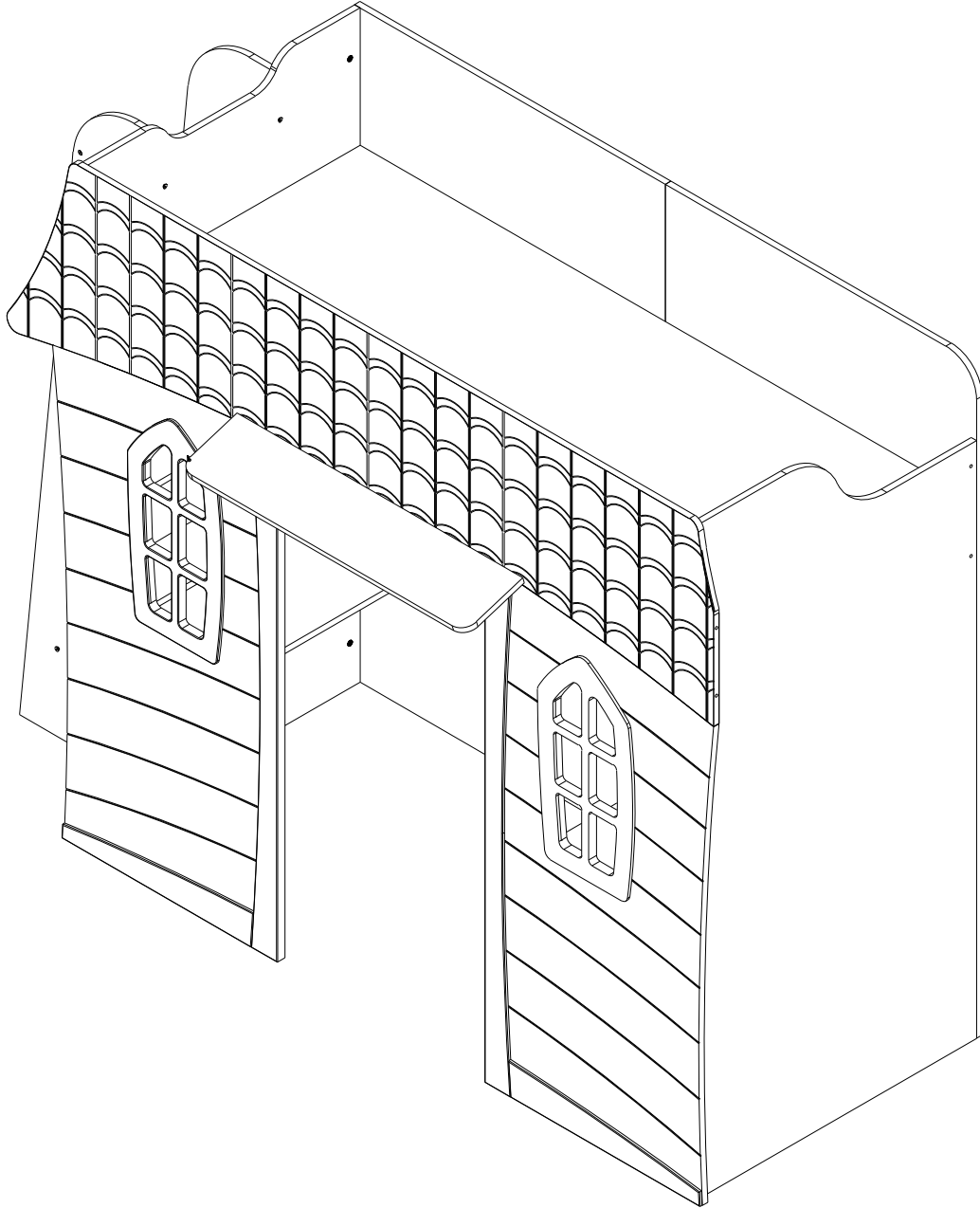



Read the warning and cleaning  
recommendations carefully. /

*Uyarı ve temizleme önerilerini dikkatlice  
okuyunuz.*